



CREATING NEW BOUNDARIES



Fencing & Landscaping

Issue 20



The latest edition of our catalogue includes over 3,000 product lines all neatly combined in one easy-to-use volume. With a whole host of products ranging from fence panels to wellington boots, as well as many extra product lines, we're confident you will find everything you require contained within this brochure.

As a family managed firm going back over 25 years and 3 generations, we have unrivalled knowledge in the fencing and landscaping industry. Constantly striving to be 'better than the rest', we take our work seriously and are willing to help out and give advice as required.

Our Values:

1. Live our Mission
2. Inspire & Create
3. Value Green Growth
4. Everyone is Vital
5. & Have Fun!

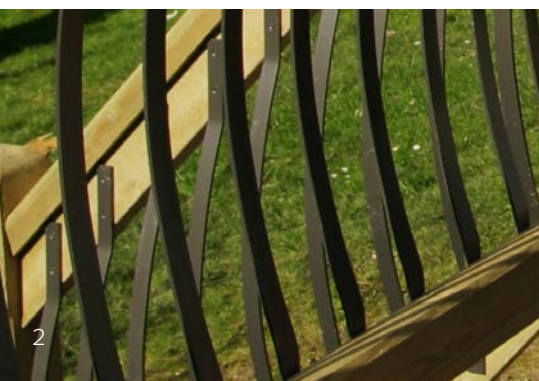

Call us on
01264 366211
 or email
sales@atfsuppliesuk.com

Have you seen our website?
www.atfsuppliesuk.com

Trade Store Hours:
 07:00-05:00
 Monday to Friday

Boundary House, 36a Walworth
 Business Park, Andover,
 Hampshire. SP10 5LH

- Quick Guides 4
- Garden Fencing & Decking 5
- Agricultural & Equestrian 21
- Wire Products 31
- Electric Fencing 35
- Gates & Accessories 45
- Industrial & Commercial 61
- Fencing Accessories 65
- Security 59
- Fixings 73
- Planting Sundries 79
- Grass Seed & Fertilisers 85
- Mulches 87
- Tools & Accessories 89
- Workwear 111



Our certifications further underline our commitment to the environment.

Remember to look out for our FSC certified products.



Determine your perimeter length



AREA (HECTARES)	AREA (ACRES)	PERIMETER LENGTH
0.1	1/4	127 metres
0.2	1/2	180 metres
0.3	3/4	220 metres
0.41	1	255 metres
0.81	2	360 metres
1.21	3	441 metres
1.62	4	509 metres
2.02	5	569 metres
4.05	10	805 metres
8.09	20	1141 metres
16.19	40	1609 metres
20.24	50	1800 metres

Calculate Feather Edge Board Required



BOARD WIDTH	OVER LAP	FINISHED WIDTH	BOARDS PER METRE
100mm	25mm	75mm	14
125mm	25mm	100mm	10
150mm	25mm	125mm	8
200mm	25mm	175mm	6

Points to remember:

- It's always wise to allow a few extra boards to ensure you have sufficient to allow for wastage.

Calculate Fence Posts Required



FENCE TYPE	BAY WIDTH	CALCULATION
Closeboard Fencing	3.0metres	Total Fence Length/3.0
Fence Panels; Timber Palisade; Post & Rail	1.8metres	Total Fence Length/1.8

Points to remember:

- Allow an additional post for the end of a fence run
 - We generally recommend 2 bags of postfix per post

Calculating m3 of Bark Mulch Required



DEPTH REQUIRED	M2 PER M3	FORMULA
50mm	20	Area (sqm) / 20 = m3 required
75mm	13	Area (sqm) / 13 = m3 required

Calculate kg of Grass Seed Required



Sowing Rate	0.05kg per m2	Total m2 x 0.05 = KG Required
Overseeding	0.02kg per m2	Total m2 x 0.02 = KG Required

Calculate Timber Palisade Pales Required



TIMBER PALE WIDTH	GAP BETWEEN PALES	PALES REQUIRED
75mm	25mm	10 /Linear Metreage
75mm	50mm	8 /Linear Metreage
75mm	75mm	7 /Linear Metreage

Calculate Deck Boards Required



DECK BOARD SIZE	M2 COVERAGE	DECK BOARDS REQUIRED
3.6m (l) x 125mm (w)	0.432m2	Total m2 / 0.432
4.2m (l) x 125mm (w)	0.504m2	Total m2 / 0.504
4.8m (l) x 125mm (w)	0.576m2	Total m2 / 0.576

Points to remember:

- Always round the total up rather than down
 - Joists should be spaced a minimum of 500mm apart



Posts & Accessories	6-8
Closeboard Materials	9-10
Panels & Trellis	11-12
Postfix & Salt	13
Preservers	13
Post Supports	14
Decking & Accessories	15-17
Garden Lighting	18-19
Sleepers & Timber	20
Boundary Demarkation	20

HC4 Square Sawn Posts



CODE	DESCRIPTION
205 06050	1.5m x 75mm x 75mm (5' x 3" x 3")
205 06060	1.8m x 75mm x 75mm (6' x 3" x 3")
205 06070	2.1m x 75mm x 75mm (7' x 3" x 3")
205 06080	2.4m x 75mm x 75mm (8' x 3" x 3")
205 09060	2.7m x 75mm x 75mm (9' x 3" x 3")
205 09070	3.0m x 75mm x 75mm (10' x 3" x 3")
205 06010	1.5m x 100mm x 100mm (5' x 4" x 4")
205 06020	1.8m x 100mm x 100mm (6' x 4" x 4")
205 06030	2.1m x 100mm x 100mm (7' x 4" x 4")
205 06040	2.4m x 100mm x 100mm (8' x 4" x 4")
205 09040	2.7m x 100mm x 100mm (9' x 4" x 4")
205 09050	3.0m x 100mm x 100mm (10' x 4" x 4")
205 09080	3.6m x 100mm x 100mm (12' x 4" x 4")
205 11180	2.4m x 125mm x 100mm (8' x 5" x 4")
205 11182	2.7m x 125mm x 100mm (9' x 5" x 4")

i For details on how to work out posts required, please turn to page 4

HC4 Morticed & V-Notched Sawn Posts



CODE	DESCRIPTION
205 11122	2.4m x 100mm x 100mm (8' x 4" x 4") c/w 3 mortice

CODE	DESCRIPTION
206 11121	2.4m x 125mm x 100mm (8' x 5" x 4") c/w 3 V-Notch

Sawn Oak

i Oak timber available cut to size
Please call 01264 366 211

Post Caps



CODE	DESCRIPTION
206 08070	100x100mm for 75x75mm post (4x4" for 3x3" Posts)
206 08090	125x125mm for 100x100mm post (5x5" for 4x4" Posts)

Ball Finials



CODE	DESCRIPTION
206 08110	Ball Finial for 3" x 3" Post
206 08120	Ball Finial for 4" x 4" Post

Acorn Finials



CODE	DESCRIPTION
206 08130	Acorn Finial for 3" x 3" Post
206 08140	Acorn Finial for 4" x 4" Post

Concrete Intermediate Slotted Posts



CODE	DESCRIPTION
215 12350	1.525m (5')
215 12340	1.83m (6')
215 12330	2.135m (7')
215 12320	2.44m (8')
215 12310	2.745m (9')
215 12315	3.04m (10')

Concrete Corner Slotted Posts

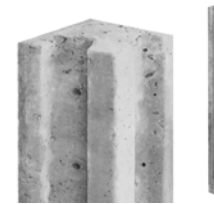

CODE	DESCRIPTION
215 12352	1.525m (5')
215 12342	1.83m (6')
215 12332	2.135m (7')
215 12322	2.44m (8')
215 12312	2.745m (9')

Concrete End Slotted Posts

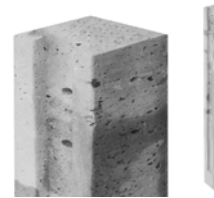

CODE	DESCRIPTION
215 12341	1.83m (6')
215 12331	2.135m (7')
215 12321	2.44m (8')
215 12311	2.745m (9')



Concrete Recessed Gravel Board



CODE	DESCRIPTION
215 12380	1.83m x 150mm x 50mm (6' x 6" x 2")
215 12370	1.83m x 305mm x 50mm (6' x 12" x 2")

Concrete Rockfaced Gravel Board



CODE	DESCRIPTION
215 12360	1.83m x 305mm x 50mm (6' x 12" x 2")

Treated Timber Gravel Board

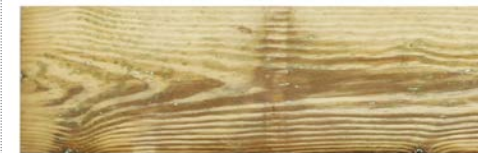

CODE	DESCRIPTION
206 11190	1.83m x 150mm x 22mm (6' x 6" x 1")

Universal Concrete Posts



CODE	DESCRIPTION
215 90430	2.44m x 100mm x 100mm
215 90440	2.75m x 100mm x 100mm

i Other posts available to order
Please call **01264 366 211**

Concrete Mortice Intermediate Posts



CODE	DESCRIPTION
215 12250	1.52m x 100mm x 100mm (5'3" x 4" x 4")
215 12240	1.83m x 100mm x 100mm (6'3" x 4" x 4")
215 12230	2.135m x 100mm x 100mm (7' x 4" x 4")
215 12220	2.44m x 100mm x 100mm (8' x 4" x 4")
215 12210	2.750m x 100mm x 100mm (9' x 4" x 4") - 2.0m Fence
215 12215	2.745m x 100mm x 100mm (9. x 4" x 4") - 1.8m Fence

Concrete Mortice Corner Posts



CODE	DESCRIPTION
215 12251	1.52m x 100mm x 100mm (5'3" x 4" x 4")
215 12241	1.83m x 100mm x 100mm (6'3" x 4" x 4")
215 12231	2.135m x 100mm x 100mm (7' x 4" x 4")
215 12221	2.44m x 100mm x 100mm (8' x 4" x 4")
215 12211	2.750m x 100mm x 100mm (9' x 4" x 4") - 2.0m Fence
215 12225	2.745m x 100mm x 100mm (9' x 4" x 4") - 1.8m Fence

i British Standard morticed posts available.
Please call **01264 366 211**

Recessed Concrete Intermediate Posts

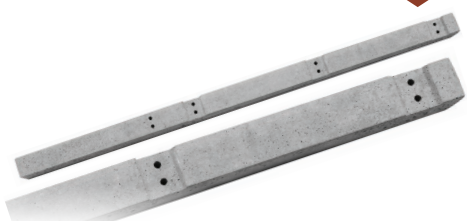

CODE	DESCRIPTION
215 12300	1.45m (4'9")
215 12290	1.525m (5')
215 12280	1.830m (6')
215 12270	2.21m (7'3")
215 12260	2.515m (8'3")

Recessed Concrete Corner Posts



CODE	DESCRIPTION
215 12301	1.45m (4'9")
215 12291	1.525m (5')
215 12281	1.830m (6')
215 12271	2.21m (7'3")
215 12261	2.515m (8'3")

Concrete Gravel Boards



CODE	DESCRIPTION
215 12201	2.885m x 150mm x 50mm (9'5" x 6" x 2") (For Morticed Posts)
215 12200	3.0m x 150mm x 50mm (9'10" x 6" x 2") (For Recessed Posts)

i Turn to page 68 for gravel board
brackets & cleats

Concrete Repair Spurs



CODE	DESCRIPTION
215 11900	1.0m x 75mm x 75mm (3'6" x 3" x 3")
215 11910	1.2m x 100mm x 100mm (4' x 4" x 4")

Plain Treated Arris Rail



CODE	DESCRIPTION
206 10010	3.0m x 2ex 75mm (10' x 2Ex 3")
206 10090	3.6m x 2ex 75mm (12' x 2Ev x 3")

Scarfed Treated Arris Rail



CODE	DESCRIPTION
206 11150	3.0m x 2Ex 75mm (10' x 2Ex 3") c/w Scarfed Ends

Treated Cant Rail



CODE	DESCRIPTION
206 10050	3.0m x 2ex 125mm x 50mm (10' x 2Ex 5" x 2")

Treated Centre Stumps/Pegs



CODE	DESCRIPTION
206 11508	450mm x 50mm x 50mm (18" x 2" x 2")
206 11509	600mm x 50mm x 50mm (2' x 2" x 2")
206 11507	600mm x 50mm x 50mm c/w 45° top (2' x 2" x 2")

Treated Counter Rail



CODE	DESCRIPTION
206 10041	3.0m x 50mm x 22mm (10' x 2" x 1")

Treated Capping Rail



CODE	DESCRIPTION
206 10040	3.0m x 65mm x 38mm (10' x 2" x 1")

Treated Timber Gravel Board



CODE	DESCRIPTION
206 10030	3.0m x 150mm x 22mm (10' x 6" x 1")
206 10000	3.6m x 100mm x 22mm (12' x 4" x 1")
206 11050	3.6m x 150mm x 22mm (12' x 6" x 1")

i For larger timber sections to use as
gravel boards, turn to page 17

Standard Treated Feather Edge



100mm Feather Edge Boards - 14/metre
 125mm Feather Edge Boards - 10/metre
 150mm Feather Edge Boards - 8/metre

CODE	DESCRIPTION
207 06011	900mm x 2ex 125mm x 22mm (3' x 5" x 2Ex 1")
207 06015	1050mm x 2ex 125mm x 22mm (3'6" x 5" x 2Ex 1")
207 06014	1200mm x 2ex 125mm x 22mm (4' x 5" x 2Ex 1")
207 06006	1350mm x 2ex 125mm x 22mm (4'6" x 5" x 2Ex 1")
207 06017	1500mm x 2ex 125mm x 22mm (5' x 5" x 2Ex 1")
207 06007	1650mm x 2ex 100mm x 22mm (5'6" x 4" x 2Ex 1")
207 06008	1650mm x 2ex 125mm x 22mm (5'6" x 5" x 2Ex 1")
207 09020	1650mm x 2ex 150mm x 22mm (5'6" x 6" x 2Ex 1")
207 09010	1800mm x 2ex 100mm x 22mm (6' x 4" x 2Ex 1")
207 06009	1800mm x 2ex 125mm x 22mm (6' x 5" x 2Ex 1")
207 09030	1800mm x 2ex 150mm x 22mm (6' x 6" x 2Ex 1")

Long Treated Feather Edge



CODE	DESCRIPTION
207 09027	2400mm x 125mm 2ex 22mm (8' x 5" x 2Ex 1")
207 09031	3600mm x 150mm 2ex 22mm (12' x 6" x 2Ex 1")
207 09032	4800mm x 200mm 2ex 32mm (16' x 7" x 2Ex 1 1/2")

i For timber stockwalling, turn to page 24



Lap Panels



CODE	DESCRIPTION
211 08020	6' (w) x 3' (h) (1830mm x 900mm)
211 08010	6' (w) x 4' (h) (1830mm x 1200mm)
211 08030	6' (w) x 5' (h) (1830mm x 1500mm)
211 08040	6' (w) x 6' (h) (1830mm x 1830mm)

Panel Batten



CODE	DESCRIPTION
211 09100	1.8m x 40mm x 40mm
211 09101	1.8m x 35mm x 19mm

Panel Capping



CODE	DESCRIPTION
211 09102	1.83m x 40mm

Closeboard Panels



CODE	DESCRIPTION
211 12540	6' (w) x 3' (h) (1830mm x 900mm)
211 12550	6' (w) x 4' (h) (1830mm x 1200mm)
211 12560	6' (w) x 5' (h) (1830mm x 1500mm)
211 12570	6' (w) x 6' (h) (1830mm x 1830mm)



Square Trellis



CODE	DESCRIPTION
211 03010	6' (w) x 1' (h) (1830mm x 300mm)
211 03020	6' (w) x 2' (h) (1830mm x 600mm)
211 03030	6' (w) x 3' (h) (1830mm x 900mm)
211 03040	6' (w) x 4' (h) (1830mm x 1200mm)
211 03050	6' (w) x 5' (h) (1830mm x 1500mm)
211 03060	6' (w) x 6' (h) (1830mm x 1830mm)

Fan Trellis



CODE	DESCRIPTION
211 04300	6' (h) x 2' (w) (1830mm x 600mm)
211 04310	3' (h) x 2' (w) (1830mm x 600mm)

Hampshire Curved Top Trellis



CODE	DESCRIPTION
211 12696	0.3m/0.42m/0.3m (h) x 1.83m (w)
211 12697	0.45m/0.57m/0.45m (h) x 1.83m (w)
211 12698	0.6m/0.72m/0.6m (h) x 1.83m (w)
211 12699	1.6m/1.8m/1.6m (h) x 1.83m (w)

Hampshire Square Frame Trellis

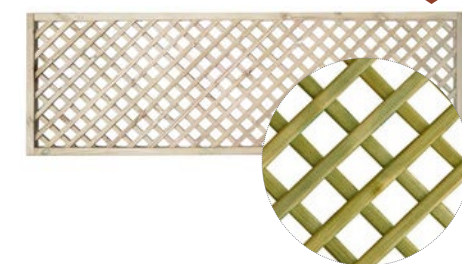

CODE	DESCRIPTION
211 12690	1.83m (w) x 0.30m (h) (6' x 1') (40mm square size)
211 12691	1.83m (w) x 0.45m (h) (6' x 1'6") (40mm square size)
211 12692	1.83m (w) x 0.60m (h) (6' x 2') (40mm square size)
211 12693	1.83m (w) x 0.90m (h) (6' x 3') (40mm square size)
211 12694	1.83m (w) x 1.20m (h) (6' x 4') (40mm square size)
211 12695	1.83m (w) x 1.83m (h) (6' x 6') (40mm square size)

Premier Salisbury Screen Panel



CODE	DESCRIPTION
211 12610	1.6m/1.8m/1.6m (h) x 1.8m (w) (5'3"/5'11"/5'3" (h) x 5'11" (w))

Panel Clips



CODE	DESCRIPTION
210 39250	Fence Panel Clip (50mm) - Galvanised
210 29251	Fence Panel Clip (47mm) - Easy Use (Brown)
210 39260	Trellis Clips (38mm)
210 16635	Scorpion Fence Panel Clip (Prevents panel rattling)

Timber Round Top Palisade Panels



CODE	DESCRIPTION
211 03081	6' (w) x 3' (h) (1800mm x 900mm)
211 03071	6' (w) x 4' (h) (1800mm x 1200mm)

Individual Round Top Palisade Pales



CODE	DESCRIPTION
211 11320	0.9m (h) x 75mm (w) x 22mm (d) (3' x 3" x 1")
211 11350	1.2m (h) x 75mm (w) x 22mm (d) (4' x 3" x 1")
211 11171	1.8m (h) x 75mm (w) x 22mm (d) (6' x 3" x 1")

Individual Pointed Top Palisade Pales



CODE	DESCRIPTION
211 11310	0.9m (h) x 75mm (w) x 22mm (d) (3' x 3" x 1")
211 11340	1.2m (h) x 75mm (w) x 22mm (d) (4' x 3" x 1")
211 11170	1.8m (h) x 75mm (w) x 22mm (d) (4' x 3" x 1")

Individual Blunt Top Palisade Pales



CODE	DESCRIPTION
211 11300	0.9m (h) x 75mm (w) x 22mm (d) (3' x 3" x 1")
211 11330	1.2m (h) x 75mm (w) x 22mm (d) (4' x 3" x 1")
211 11070	1.8m (h) x 75mm (w) x 22mm (d) (6' x 3" x 1")

Wattle Hurdles



CODE	DESCRIPTION
211 05233	6' (w) x 3' (h) (1830mm x 900mm)
211 05232	6' (w) x 4' (h) (1830mm x 1200mm)
211 05231	6' (w) x 4'6" (h) (1830mm x 1350mm)
211 05230	6' (w) x 6' (h) (1830mm x 1830mm)

Postfix



CODE	DESCRIPTION
209 08060	Postfix - Standard (20kg)
209 08061	Postfix - Rapid Set (20kg)

Salt



CODE	DESCRIPTION
209 11620	Rocksalt 25 Kg
209 11621	White De-icing salt 25kg



Creosote



CODE	DESCRIPTION
241 30890	Dark Brown 25ltr - Traditional
241 30900	Light Brown 20ltr - Substitute
241 30480	Dark Brown 4ltr - Substitute
241 30490	Light Brown 4ltr - Substitute

Ensele - End Grain Preserver



CODE	DESCRIPTION
241 30470	Ensele - Green 1 litre
241 30475	Ensele - Green 5 litre

i See page 98 for our selection of paint brushes

Pressure Sprayer



CODE	DESCRIPTION
241 25241	5Ltr Pressure Sprayer

Wood Preservers - 25ltr



CODE	DESCRIPTION
241 30830	Dark Brown
241 30840	Light Brown
241 30850	Green
241 30860	Red Cedar

Wood Preservers - 5ltr



CODE	DESCRIPTION
241 30400	Dark Brown
241 30410	Golden Brown
241 30420	Dark Green
241 30430	Red cedar
241 30440	Clear
241 30450	Universal

Linseed Oil



CODE	DESCRIPTION
241 36460	Raw Linseed 2.5ltr
241 36470	Boiled Linseed 2.5ltr

Holdfast Post Support - To Drive

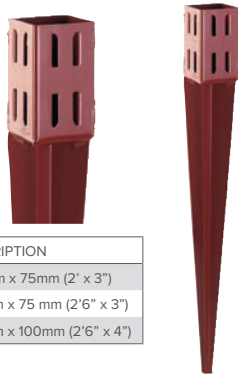

CODE	DESCRIPTION
210 39060	600mm x 75mm (2' x 3")
210 39070	750mm x 75 mm (2'6" x 3")
210 39080	750mm x 100mm (2'6" x 4")

Swiftclamp Post Support - To Drive



CODE	DESCRIPTION
210 39090	600mm x 75mm (2' x 3")
210 39100	750mm x 75 mm (2'6" x 3")
210 39110	750mm x 100mm (2'6" x 4")

Repair Spur



CODE	DESCRIPTION
210 39230	75mm (3")
210 39240	100mm (4")

Driving Tools



CODE	DESCRIPTION
210 39140	75mm (3")
210 39150	100mm (4")

Holdfast Post Support - Bolt Down



CODE	DESCRIPTION
210 39170	75mm (3")
210 39180	100mm (4")

Swiftclamp Post Support - Bolt Down



CODE	DESCRIPTION
210 39190	75mm (3")
210 39200	100mm (4")

Post Extender



CODE	DESCRIPTION
210 39270	75mm (3") Extender
210 39280	100mm (4") Extender

Decking Boards



CODE	DESCRIPTION
213 11607	3.0m x 125mm x 32mm (10' x 5" x 1¼") (Nominal Size)
213 11606	3.6m x 125mm x 32mm (12' x 5" x 1¼") (Nominal Size)
213 11603	4.8m x 125mm x 32mm (16' x 5" x 1¼") (Nominal Size)

Decking Hidden Fastener Tool



CODE	DESCRIPTION
311 00150	Camo Hidden Fastening Tool (80-125mm Boards)
231 00151	46mm Camo Fastening Screws - Pack 200
231 00152	60mm Camo Fastening Screws - Pack 200

Decking Hand Rail



CODE	DESCRIPTION
213 11671	Hand Rail 1800mm (6')
213 11673	Hand Rail 2400mm (8')

Decking Base Rail



CODE	DESCRIPTION
213 11672	Base Rail 1800mm (6')
213 11674	Base Rail 2400mm (8')

Anti-slip Decking Inserts



CODE	DESCRIPTION
213 63085	DeckWright Anti-Slip Inserts Kit - 25no. 1m lengths & 1no. tube adhesive
213 63085	DeckWright Adhesive - Additional Tube

Decking Panel



CODE	DESCRIPTION
213 11675	Ornate Rail - 1800mm (w) x 985mm (h) (6' x 3' 2½")
213 11675	Straight Rail - 1800mm (w) x 985mm (h) (6' x 3' 2½")

Decking Newel Posts & Spindles



CODE	DESCRIPTION
213 11644	1.3m x 80mm x 80mm Square Newel Post
213 11700	1.3m x 80mm x 80mm Turned Newel Post
213 11645	895mm x 40 x 40mm Square Spindle
213 11640	895mm x 80 x 40mm Turned Spindle

Hex Head Screws



CODE	DESCRIPTION
232 14521	Carpenters Mate Hex Head Screw 140mm - Bx 100
232 14507	Carpenters Mate Hex Head Screw 140mm - Pk 25
232 14522	Carpenters Mate Hex Head Screw 190mm - Box 100
232 14508	Carpenters Mate Hex Head Screw 190mm - Pk 10
232 14523	Carpenters Mate Hex Head Screw 240mm - Box 100
232 14509	Carpenters Mate Hex Head Screw 240mm - Pk 10
232 14520	Carpenters Mate Hex Head Screw 90mm - Bx 100
232 14506	Carpenters Mate Hex Head Screw 90mm - Pk 25

Hex Head Driver Bit



CODE	DESCRIPTION
232 14505	Driver Bit (for hex head screws)

Decking Screws



CODE	DESCRIPTION
232 14510	Deckscrews 40mm (1 1/2") - Bx 200
232 14511	Deckscrews 50mm(2") - Bx 200
232 14512	Deckscrews 60mm (2 1/2") - Box 200
232 14515	Deckscrews 60mm (2 1/2") Bucket 2000
232 14514	Deckscrews 75mm (3") - Box 200
232 14516	Deckscrews 90mm (3 1/2") - Bx 200

Deckscrew Driver Bit



CODE	DESCRIPTION
232 14513	Square Driver Bit (for Deckscrews) (Pk 2)

Angle Brackets



CODE	DESCRIPTION
213 63090	90mm x 90mm x 63mm Heavy Duty Angle Bracket
213 63070	60mm x 60mm x 40mm Light Duty Angle Bracket

Hand Rail/Balustrade Bracket



CODE	DESCRIPTION
226 38430	40mm x 40mm x 30mm Lightweight Angle Bracket

Staircase Angle Bracket Kit

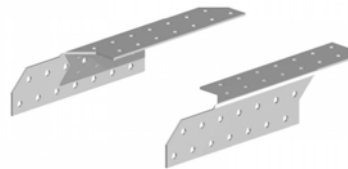

CODE	DESCRIPTION
213 63040	Staircase Angle Bracket Kit (3 pairs)

Joist Hanger 100mm

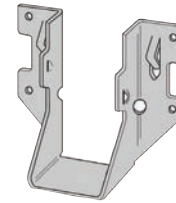

CODE	DESCRIPTION
213 63060	Joist hanger 100 x 50mm (4" x 2")

Joist Hanger 150mm



CODE	DESCRIPTION
213 63061	Joist hanger 150mm x 50mm (6" x 2")

Oak Sleepers



CODE	DESCRIPTION
211 12405	2.4m x 200mm x 100mm (8' x 8" x 4")

Garden Sleepers



CODE	DESCRIPTION
211 12401	2.4m x 250mm x 125mm - HC4 (8' x 10" x 5")
211 12402	2.4m x 200mm x 100mm - HC4 (8' x 8" x 4")

Treated Sawn Timber



CODE	DESCRIPTION
204 11639	4.8m x 38mm x 19mm (16' x 1 1/2" x 3/4")
204 10041	3.0m x 50mm x 22mm (10' x 2" x 1")
204 11240	4.8m x 50mm x 47mm (16' x 2" x 2")
204 11241	3.6m x 50mm x 47mm (12' x 2" x 2")
204 11581	3.6m x 75mm x 50mm (12' x 3" x 2")
204 11580	4.8m x 75mm x 50mm (16' x 3" x 2")
204 11031	3.0m x 88mm x 38mm (10' x 3 1/2" x 1 1/2")
204 11030	3.6m x 88mm x 38mm (12' x 3 1/2" x 1 1/2")
204 90030	3.6m x 100mm x 38mm (12' x 4" x 1 1/2")
204 11042	1.8m x 100mm x 47mm (6' x 4" x 2")
204 11041	3.0m x 100mm x 47mm (10' x 4" x 2")
204 11040	3.6m x 100mm x 47mm (12' x 4" x 2")
204 11570	4.8m x 100mm x 47mm (16' x 4" x 2")
204 10030	3.0m x 150mm x 22mm (10' x 6" x 1")
204 11050	3.6m x 150mm x 22mm (12' x 6" x 1")
204 11060	3.0m x 150mm x 47mm (10' x 6" x 2")
204 11560	3.6m x 150mm x 47mm (12' x 6" x 2")
204 11561	4.8m x 150mm x 47mm (16' x 6" x 2")
204 11201	3.6m x 175mm x 47mm (12' x 7" x 2")



Hard Wired Starter Box



CODE	DESCRIPTION
222 14840	Easy Connect Starter Box

UK Starter Plug Lead



CODE	DESCRIPTION
222 14841	Easy Connect Starter Plug

Non-Standard Starter Box



CODE	DESCRIPTION
222 14842	Easy Connect Adaptor

Extension Lead



CODE	DESCRIPTION
222 14843	Easy Connect - 0.5mtr
222 14844	Easy Connect - 1.0mtr
222 14845	Easy Connect - 2.5mtr
222 14846	Easy Connect - 5.0mtr

T Connector



CODE	DESCRIPTION
222 14848	Easy Connect T Connector

X Connector



CODE	DESCRIPTION
222 14849	Easy Connect X Connector

Y Connector



CODE	DESCRIPTION
222 14850	Easy Connect Y Connector

Flex Connector - 2 Outputs



CODE	DESCRIPTION
222 14852	Easy Connect 170mm (pk2)

Flex Connector - 5 Outputs



CODE	DESCRIPTION
222 14853	Easy Connect 1mtr (pk1)

Spare Bulb - MR20 GU10



CODE	DESCRIPTION
222 14860	Easy Connect - Cool White
222 14861	Easy Connect - Blue
222 14862	Easy Connect - Green
222 14863	Easy Connect - Red

Control Box (Inc 2 Switches)



CODE	DESCRIPTION
222 14864	Easy Connect - On/Off

Multifunction Control Box



CODE	DESCRIPTION
222 14866	Easy Connect - Control Box

Deck Lights - 45mm (pk 6)



CODE	DESCRIPTION
222 14868	Easy Connect - Cool White
222 14869	Easy Connect - Blue
222 14870	Easy Connect - Warm White

Deck Lights - 60mm (pk 3)



CODE	DESCRIPTION
222 14871	Easy Connect - Cool White
222 14872	Easy Connect - Blue
222 14873	Easy Connect - Warm White

Deck Lights - 75mm (pk 1)



CODE	DESCRIPTION
222 14874	Easy Connect - Cool White
222 14875	Easy Connect - Blue
222 14876	Easy Connect - Warm White

i Turn to page 102 for our range of auger drill bits

Deck Lights - 100mm (pk 1)



CODE	DESCRIPTION
222 14877	Easy Connect - Cool White
222 14878	Easy Connect - Blue
222 14879	Easy Connect - Warm White

Stone Series



CODE	DESCRIPTION
222 14882	Easy Connect - Warm White

Avant Series - Black



CODE	DESCRIPTION
222 14885	Easy Connect - Warm White

Avant Series - Aluminium



CODE	DESCRIPTION
222 14886	Easy Connect - Warm White

Maxi Deck Light 110mm



CODE	DESCRIPTION
222 14880	Easy Connect - Warm White

Stainless Pond Series - IP68



CODE	DESCRIPTION
222 14889	Easy Connect - 2mtr Cable

Bollard Series



CODE	DESCRIPTION
222 14893	Easy Connect - Stainless Steel Bollard



Pointed Machined Round Stakes



CODE	DESCRIPTION
203 12410	Treated Machined Stakes 1.65m x 50mm (5'6" x 2")
203 12420	Treated Machined Stakes 1.8m x 50mm (6' x 2")
203 12430	Treated Machined Stakes 1.65m x 75mm (5'6" x 3")
203 12440	Treated Machined Stakes 1.8m x 75mm (6' x 3")
203 90450	Treated Machined Stakes 2.4m x 75mm (8' x 3")
203 12460	Treated Machined Stakes 1.65m x 85mm (5'6" x 3 1/4")
203 12470	Treated Machined Stakes 1.8m x 85mm (6' x 3 1/4")
203 90480	Treated Machined Stakes 2.4m x 85mm (8' x 3 1/4")
203 12490	Treated Machined Stakes 1.65m x 100mm (5'6" x 4")
203 12500	Treated Machined Stakes 1.8m x 100mm (6' x 4")
203 90510	Treated Machined Stakes 2.4m x 100mm (8' x 4")
203 90520	Treated Machined Strainers 2.1m x 125mm (7' x 5")
203 90530	Treated Machined Strainers 2.1m x 150mm (7' x 6")

Machined Round Poles



CODE	DESCRIPTION
203 11220	Treated Machined Jump Pole 3.6m x 100mm (12' x 4")
203 90560	Treated Machined Jump Pole 3.6m x 125mm (12' x 5")
203 90570	Treated Machined Jump Pole 3.6m x 150mm (12' x 6")

Machined Half Round Timber

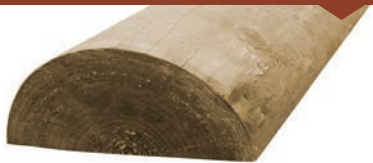

CODE	DESCRIPTION
203 90540	Treated Machined Stakes 1.65m x 100mm (5'6" x 4")
203 90550	Treated Machined Stakes 1.8m x 100mm (6' x 4")
203 11010	Treated Machined Rails 3.6m x 85mm (12' x 3 1/4")
203 11020	Treated Machined Rails 3.6m x 100mm (12' x 4")

Blunt & Pointed Dragons Teeth



CODE	DESCRIPTION
201 11950	Treated Softwood DT1 Dragons Teeth (Blunt) 3' x 5" - 6" c/w half back weather (900mm x 125-150mm)
201 11955	Treated Softwood DT3 Dragons Teeth (Pointed) 3' x 5" - 6" c/w half back weather (900mm x 125-150mm)

Treated Bird Mouth Posts



CODE	DESCRIPTION
205 06025	Bird Mouth Post 0.9m x 100mm x 100mm (3' x 4" x 4")
205 06045	Bird Mouth Post 1.2m x 100mm x 100mm (4' x 4" x 4")

Timber Knee Rail



CODE	DESCRIPTION
205 06050	Treated Knee Rail 1.5m x 75mm x 75mm (5' x 3" x 3")
205 06060	Treated Knee Rail 1.8m x 75mm x 75mm (8' x 3" x 3")
205 09070	Treated Knee Rail 3.0m x 75mm x 75mm (10' x 3" x 3")
205 09090	Treated Knee Rail 3.6m x 75mm x 75mm (12' x 3" x 3")

Galvanised Birdmouth Straps

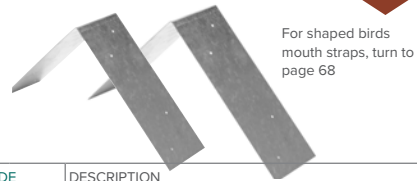

CODE	DESCRIPTION
205 16600	Galvanised Birdmouth straps 50mm (2")
205 16601	Galvanised Birdmouth straps 75mm (3")
205 16610	Galvanised Birdmouth straps 100mm (4")

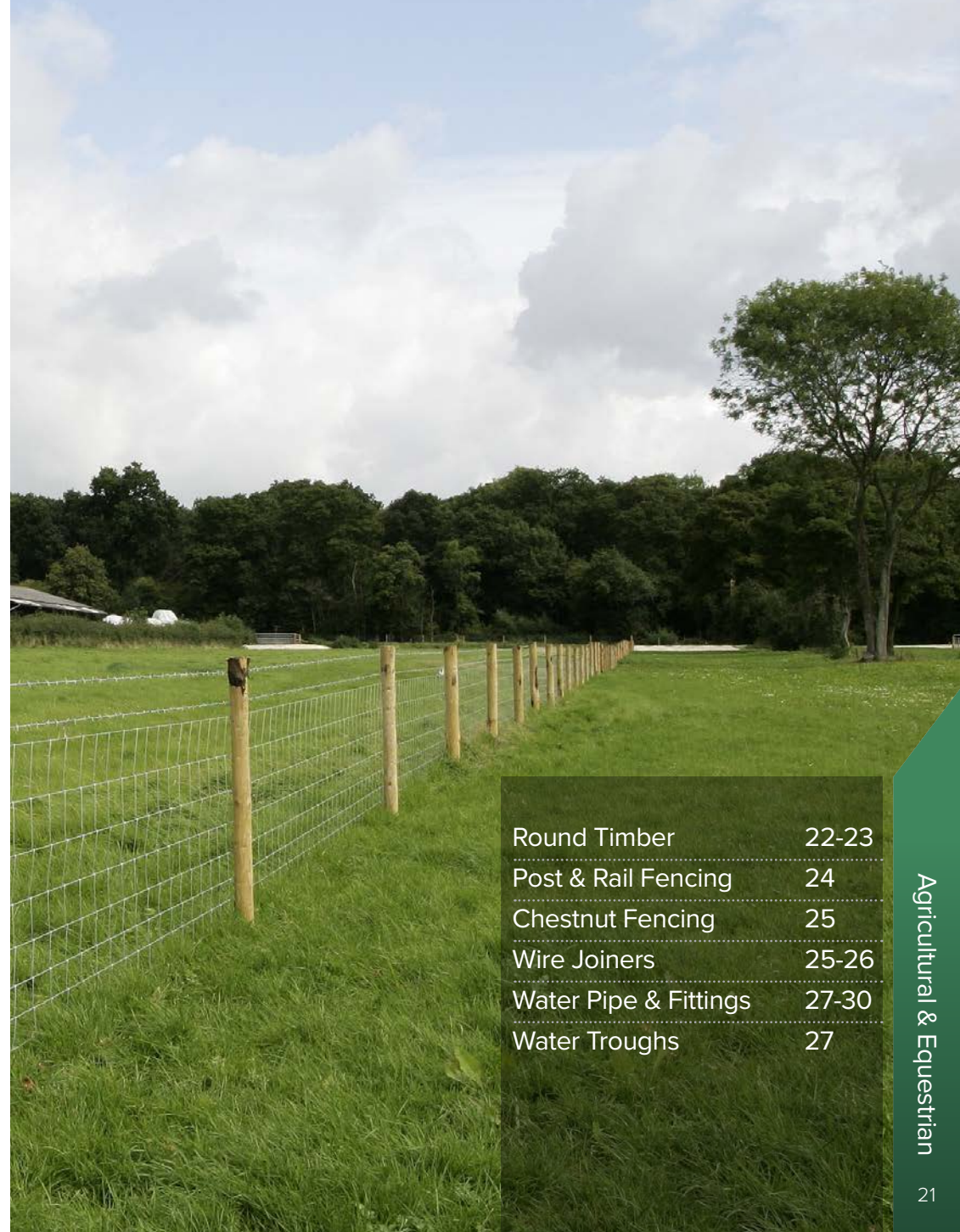

Round Timber	22-23
Post & Rail Fencing	24
Chestnut Fencing	25
Wire Joiners	25-26
Water Pipe & Fittings	27-30
Water Troughs	27

Half Round Pointed Stakes



CODE	DESCRIPTION
201 12000	Treated Half Round Stakes Pointed 5'6" x 4" - 5"
201 12010	Treated Half Round Stakes Pointed 6' x 4" - 5"

HC4 Round Pointed Stakes & Strainers



CODE	DESCRIPTION
201 12074	HC4 Treated Round Stakes Pointed 5'6" x 3" - 4"
201 12084	HC4 Treated Round Stakes Pointed 6' x 3" - 4"
201 12184	HC4 Treated Round Stakes Pointed 8' x 3" - 4"
201 12185	HC4 Treated Round Stakes Pointed 9' x 3" - 4"
201 12186	HC4 Treated Round Stakes Pointed 9' x 4" - 5"
201 12134	HC4 Treated Round Strainer Pointed 7' x 5" - 6"
201 12135	HC4 Treated Round Strainer Pointed 8' x 5" - 6"
201 12144	HC4 Treated Round Strainer Pointed 10' x 5" - 6"
204 12334	HC4 Treated Round Strainer Pointed 7' x 6" - 7"
201 12182	HC4 Treated Round Strainer Pointed 8' x 6" - 7"
201 12181	HC4 Treated Round Strainer Pointed 7' x 7" - 8"
201 12145	HC4 Treated Round Strainer Pointed 8' x 7" - 8"

HC4 Round Struts



CODE	DESCRIPTION
201 12180	HC4 Treated Round Struts Blunt 8' x 3" - 4"

Half Round Rails



CODE	DESCRIPTION
201 11000	Treated Half Round Rails 12' x 3 1/2" - 4 1/2"

Round Pointed Stakes



CODE	DESCRIPTION
201 12020	Treated Round Stakes Pointed 5'6" x 2" - 3"
201 12030	Treated Round Stakes Pointed 6' x 2" - 3"
201 12040	Treated Round Stakes Pointed 8' x 2" - 3"

Machined Round Jump Poles



CODE	DESCRIPTION
203 11220	Treated Machined Round Jump Pole 3.6m x 100mm
203 90560	Treated Machined Round Jump Pole 3.6m x 125mm
203 90570	Treated Machined Round Jump Pole 3.6m x 150mm

Pointed Machined Round Stakes & Strainers



CODE	DESCRIPTION
203 12390	Treated Machined Round Stakes 1.2m x 50mm
203 12409	Treated Machined Round Stakes 1.5m x 50mm
203 12410	Treated Machined Round Stakes 1.65m x 50mm
203 12420	Treated Machined Round Stakes 1.8m x 50mm
203 12425	Treated Machined Round Stakes 1.65m x 60mm
203 12426	Treated Machined Round Stakes 1.8m x 60mm
203 12427	Treated Machined Round Stakes 2.4m x 60mm
203 12430	Treated Machined Round Stakes 1.65m x 75mm
203 12440	Treated Machined Round Stakes 1.8m x 75mm
203 90450	Treated Machined Round Stakes 2.4m x 75mm
203 12460	Treated Machined Round Stakes 1.65m x 85mm
203 12470	Treated Machined Round Stakes 1.8m x 85mm
203 90480	Treated Machined Round Stakes 2.4m x 85mm
203 12490	Treated Machined Round Stakes 1.65m x 100mm
203 12500	Treated Machined Round Stakes 1.8m x 100mm
203 90510	Treated Machined Round Stakes 2.4m x 100mm
203 90520	Treated Machined Round Strainers 2.1m x 125mm
203 90530	Treated Machined Round Strainers 2.1m x 150mm

Machined Half Round Pointed Stakes



CODE	DESCRIPTION
203 90540	Treated Machined Half Round Stakes 1.65m x 100mm
203 90550	Treated Machined Half Round Stakes 1.8m x 100mm

Machined Half Round Rails



CODE	DESCRIPTION
203 11010	Treated Machined Half Round Rails 3.6m x 85mm
203 11020	Treated Machined Half Round Rails 3.6m x 100mm

HC4 Machined Round Timber



CODE	DESCRIPTION
203 12494	HC4 Treated Machine Round Stakes 1.65m x 100mm
203 12504	HC4 Treated Machined Round Stakes 1.8m x 100mm

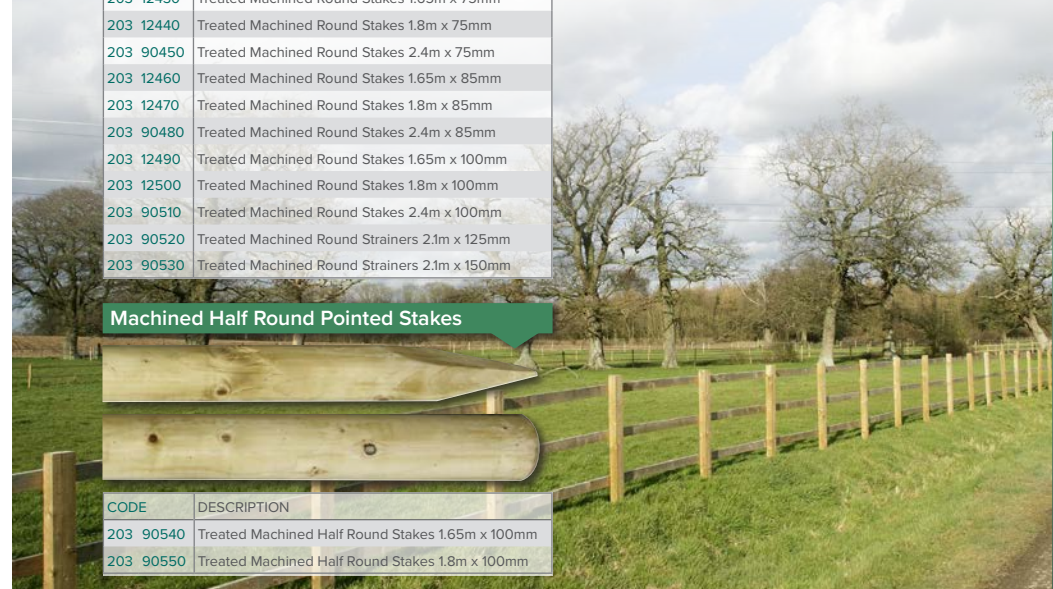

Square Sawn Rail



CODE	DESCRIPTION
204 11030	3.6m x 88mm x 38mm (12' x 3½" x 1½") Rail
204 90030	3.6m x 100mm x 38mm (12' x 4" x 1½") Rail

HC4 Pointed Posts



CODE	DESCRIPTION
204 11550	HC4 1.8m x 100mm x 75mm (6' x 4" x 3") Pointed Post
204 11540	HC4 1.8m x 125mm x 75mm (6' x 5" x 3") Pointed Post
204 11575	HC4 1.8m x 150mm x 75mm (6' x 6" x 3") Pointed Post
204 11524	HC4 2.1m x 100mm x 75mm (7' x 4" x 3") Pointed Post
204 11545	HC4 2.1m x 125mm x 75mm (7' x 5" x 3") Pointed Post
204 11585	HC4 2.1m x 150mm x 75mm (7' x 6" x 3") Pointed Post

Pressure Treated Timber Stockwalling



CODE	DESCRIPTION
204 11202	Tongue & Groove Stockwalling 4.8m x 200mm x 47mm (16' x 8" x 2")

i For feather edge cladding, turn to page 10

Ring On Plate



CODE	DESCRIPTION
223 15770	Ring On Plate

Manger Ring



CODE	DESCRIPTION
223 15780	Manger Ring 3"

Staple on Plate



CODE	DESCRIPTION
223 15790	Staple on Plate

Slip Rail Bracket



CODE	DESCRIPTION
223 15750	Slip Rail Bracket

Cleft Chestnut Rail



CODE	DESCRIPTION
202 90300	9'6" Cleft chestnut rail (Ended for mortice)

Half Round Chestnut Posts



CODE	DESCRIPTION
202 90603	6'6" Half round chestnut post with 2 mortices
202 90604	6'6" Half round chestnut post with 3 mortices

i Pressure treated softwood and oak morticed posts available to order

Chestnut Paling



CODE	DESCRIPTION
202 02010	3' High 2 Line Wire x 10 Yards
202 02011	3'6" High 2 Line Wire x 10 Yards
202 02020	4' High 2 Line Wire x 10 Yards
202 02030	4' High 3 Line Wire x 10 Yards
202 02031	5' High 3 Line Wire x 5 Yards
202 02032	6' High 3 Line Wire x 5 Yards

Griple Tensioning Tool



CODE	DESCRIPTION
227 16670	Griple tensioning tool

Gripples



CODE	DESCRIPTION
227 16680	Small gripples for 1.0 mm - 2.00 mm wire
227 16690	Medium gripples for 2.0 mm - 3.25 mm wire
227 16710	Maxi/ Jumbo gripples for 2.5 mm - 4.00 mm wire
227 16700	Large gripples for barbed wire & 4.0 mm wire

Contractors Griple Tensioning Tool



CODE	DESCRIPTION
227 16671	Griple contractors tensioning tool

Ring Clips & Pliers



CODE	DESCRIPTION
227 16721	Rosetto CL22 ring pliers
227 16730	Hogg rings - galvanised to BS443 (per 1000)

Rapid Ring Clips & Pliers



CODE	DESCRIPTION
227 16732	Rapid ring clip plier FP222
227 16731	Rapid ring clips VR22 (per 1600) Galvanised
227 16733	Rapid ring clips VR22 (per 1600) Green Coated

Ezecrimp Tools



CODE	DESCRIPTION
227 16391	Ezecrimp Tool - for all sleeves

Netting Fasteners & tool



CODE	DESCRIPTION
227 16380	Sheradized heavy netting fasteners
227 16390	Malleable Iron Pliers - for closing netting fasteners

Ezecrimp Tools



CODE	DESCRIPTION
311 18400	Ezecrimp Fence Pliers

Ezecrimp Sleeves



CODE	DESCRIPTION
227 16400	Crimp sleeves 1.6 mm - 2.5 mm
227 16401	Crimp sleeves 2.5 mm - 3.15 mm
227 16402	Crimp sleeves 4.0 mm & barbed wire

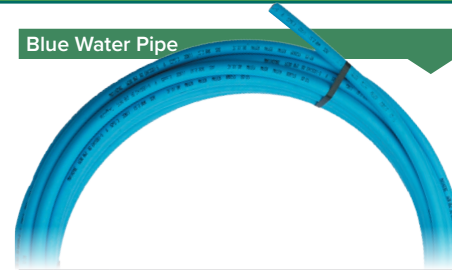

CODE	DESCRIPTION
320 50000	20mm MDPE Blue (Below Ground) x 25 Meters
320 50010	20mm MDPE Blue (Below Ground) x 50 Meters
320 50020	20mm MDPE Blue (Below Ground) x 100 Meters
320 50030	25mm MDPE Blue (Below Ground) x 25 Meters
320 50040	25mm MDPE Blue (Below Ground) x 50 Meters
320 50050	25mm MDPE Blue (Below Ground) x 100 Meters
320 50060	32mm MDPE Blue (Below Ground) x 25 Meters
320 50070	32mm MDPE Blue (Below Ground) x 50 Meters
320 50080	32mm MDPE Blue (Below Ground) x 100 Meters

Brass Taps



CODE	DESCRIPTION
321 66180	1/2" Standard Brass Tap
321 66182	1/2" c/w Double Check Valve
321 66183	3/4" c/w Double Check Valve

Ball Valves

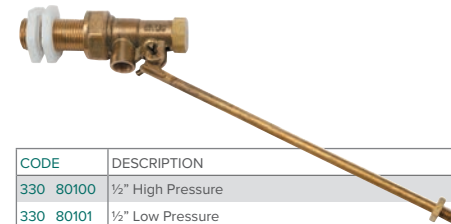

CODE	DESCRIPTION
330 80100	1/2" High Pressure
330 80101	1/2" Low Pressure
330 80103	3/4" Low Pressure
330 80102	3/4" High Pressure

Ball Floats



CODE	DESCRIPTION
330 80110	4 1/2" dia polythene

PTFE Tape



CODE	DESCRIPTION
321 80120	PTFE Tape

Water Troughs

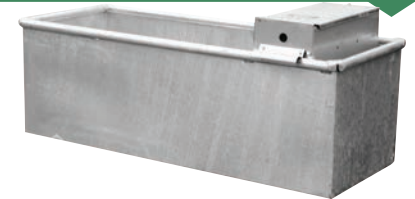

All troughs are 457mm (1'6") wide and 405mm (1'4") deep

CODE	DESCRIPTION
330 90540	0.6m (2') Long - 102 Litres - 24 Gallons
330 90600	0.9m (3') Long - 163 Litres - 36 Gallons
330 90610	1.22m (4') Long - 218 Litres - 48 Gallons
330 90620	1.5m (5') Long - 272 Litres - 60 Gallons
330 90630	1.83m (6') Long - 327 Litres - 72 Gallons
330 90640	2.44m (8') Long - 436 Litres - 96 Gallons
330 90650	3.05m (10') Long - 545 Litres - 120 Gallons

i Does not include service box - see below. Other sizes available to order.

Service Box



CODE	DESCRIPTION
330 90700	Service Box to fit above Water Troughs

Water Pipe Coupling



CODE	DESCRIPTION
321 66000	Coupling (7010) 20mm
321 66001	Coupling (7010) 25mm
321 66002	Coupling (7010) 32mm

Water Pipe Repair Coupling



CODE	DESCRIPTION
321 66010	Repair Coupling (7610) 20mm
321 66011	Repair Coupling (7610) 25mm
321 66012	Repair Coupling (7610) 32mm2

Male Thread Adaptor



CODE	DESCRIPTION
321 66020	Male Adaptor BSP Thread (7020) 20mm - 1/2"
321 66021	Male Adaptor BSP Thread (7020) 25mm - 3/4"
321 66022	Male Adaptor BSP Thread (7020) 32mm - 1"

Water Pipe Reducing Coupling



CODE	DESCRIPTION
321 66030	Reducing Coupling (7110) 25mm - 20mm
321 66031	Reducing Coupling (7110) 32mm - 25mm
321 66032	Reducing Coupling (7110) 32mm - 20mm

Female Thread Adaptor



CODE	DESCRIPTION
321 66040	Female Adaptor BSP Thread (7030) 20mm - 1/2"
321 66041	Female Adaptor BSP Thread (7030) 25mm - 3/4"
321 66042	Female Adaptor BSP Thread (7030) 32mm - 1"

Tee



CODE	DESCRIPTION
321 66050	90° Tee (7040) 20mm
321 66051	90° Tee (7040) 25mm
321 66052	90° Tee (7040) 32mm0

Reducing Tee



CODE	DESCRIPTION
321 66060	90° Reducing Tee (7340) 25mm - 20mm - 25mm
321 66061	90° Reducing Tee (7340) 32mm - 25mm - 32mm

Elbow



CODE	DESCRIPTION
321 66070	90° Elbow (7050) 20mm
321 66071	90° Elbow (7050) 25mm
321 66072	90° Elbow (7050) 32mm

90° Elbow With Female Offtake



CODE	DESCRIPTION
321 66080	Elbow With Threaded Female Offtake (7150) 20mm - 1/2"
321 66081	Elbow With Threaded Female Offtake (7150) 20mm - 3/4"
321 66082	Elbow With Threaded Female Offtake (7150) 25mm - 3/4"
321 66083	Elbow With Threaded Female Offtake (7150) 25mm - 1"
321 66084	Elbow With Threaded Female Offtake (7150) 32mm - 1"

90° Tee With Female Offtake



CODE	DESCRIPTION
321 66090	Tee With Threaded Female Offtake (7140) 20 - 1/2" - 20mm
321 66091	Tee With Threaded Female Offtake (7140) 25 - 3/4" - 25mm
321 66092	Tee With Threaded Female Offtake (7140) 32 - 1" - 32mm

Reducing Elbow



CODE	DESCRIPTION
321 66100	Reducing Elbow (7510) 25mm - 20mm

Slip Coupling



CODE	DESCRIPTION
321 66110	Metric To Imperial Slip Coupling (7418) 25mm - 3/4"

Gun Metal Stop Tap (For below ground use)



CODE	DESCRIPTION
321 66120	Gun Metal Stop Tap BS5433 (9050) 20mm
321 66121	Gun Metal Stop Tap BS5433 (9050) 25mm

Compression Stop Tap



CODE	DESCRIPTION
321 66130	Compression Stop Tap BS5433 (3407) 20mm
321 66131	Compression Stop Tap BS5433 (3407) 25mm
321 66132	Compression Stop Tap BS5433 (3407) 32mm

Wall Plate Elbow



CODE	DESCRIPTION
321 66140	Wall Plate Elbow (9055) 20mm
321 66141	Wall Plate Elbow (9055) 25mm

Blanking Plug



CODE	DESCRIPTION
321 66150	Blanking Plug (7129) 20mm
321 66151	Blanking Plug (7129) 25mm
321 66152	Blanking Plug (7129) 32mm

Plasson Universal Adaptor



CODE	DESCRIPTION
321 66160	(7896) 20 - 15mm
321 66161	(7896) 25 - 22mm
321 66162	(7896) 32 - 28mm

Plasson Threaded Socket



CODE	DESCRIPTION
321 65500	Threaded Socket (5017) 1/2"
321 65501	Threaded Socket (5017) 3/4"
321 65502	Threaded Socket (5017) 1"

Plasson Threaded Reducing Bush



CODE	DESCRIPTION
321 65510	Threaded Reducing Bush (5027) 3/4" - 1/2"
321 65511	Threaded Reducing Bush (5027) 1" - 1/2"
321 65512	Threaded Reducing Bush (5027) 1" - 3/4"

Plasson Universal Coupler



CODE	DESCRIPTION
321 66112	Universal Coupler 25 x 14 - 18
321 66113	Universal Coupler 25 x 19 - 22
321 66114	Universal Coupler 25 x 24 - 28

Plasson Threaded Nipple



CODE	DESCRIPTION
321 65520	Threaded Nipple (5067) 1/2"
321 65521	Threaded Nipple (5067) 3/4"
321 65522	Threaded Nipple (5067) 1"

Plasson Threaded Reducing Nipple



CODE	DESCRIPTION
321 65530	Threaded Reducing Nipple (5065) 3/4" - 1/2"
321 65531	Threaded Reducing Nipple (5065) 1" - 1/2"
321 65532	Threaded Reducing Nipple (5065) 1" - 3/4"

Plasson Threaded Plug



CODE	DESCRIPTION
321 65540	Threaded Plug 1/2"
321 65541	Threaded Plug 3/4"
321 65542	Threaded Plug 1"

Plasson Pipe Liner



CODE	DESCRIPTION
321 65413	Pipe Liner (7950) 20mm
321 65414	Pipe Liner (7950) 25mm
321 65415	Pipe Liner (7950) 32mm

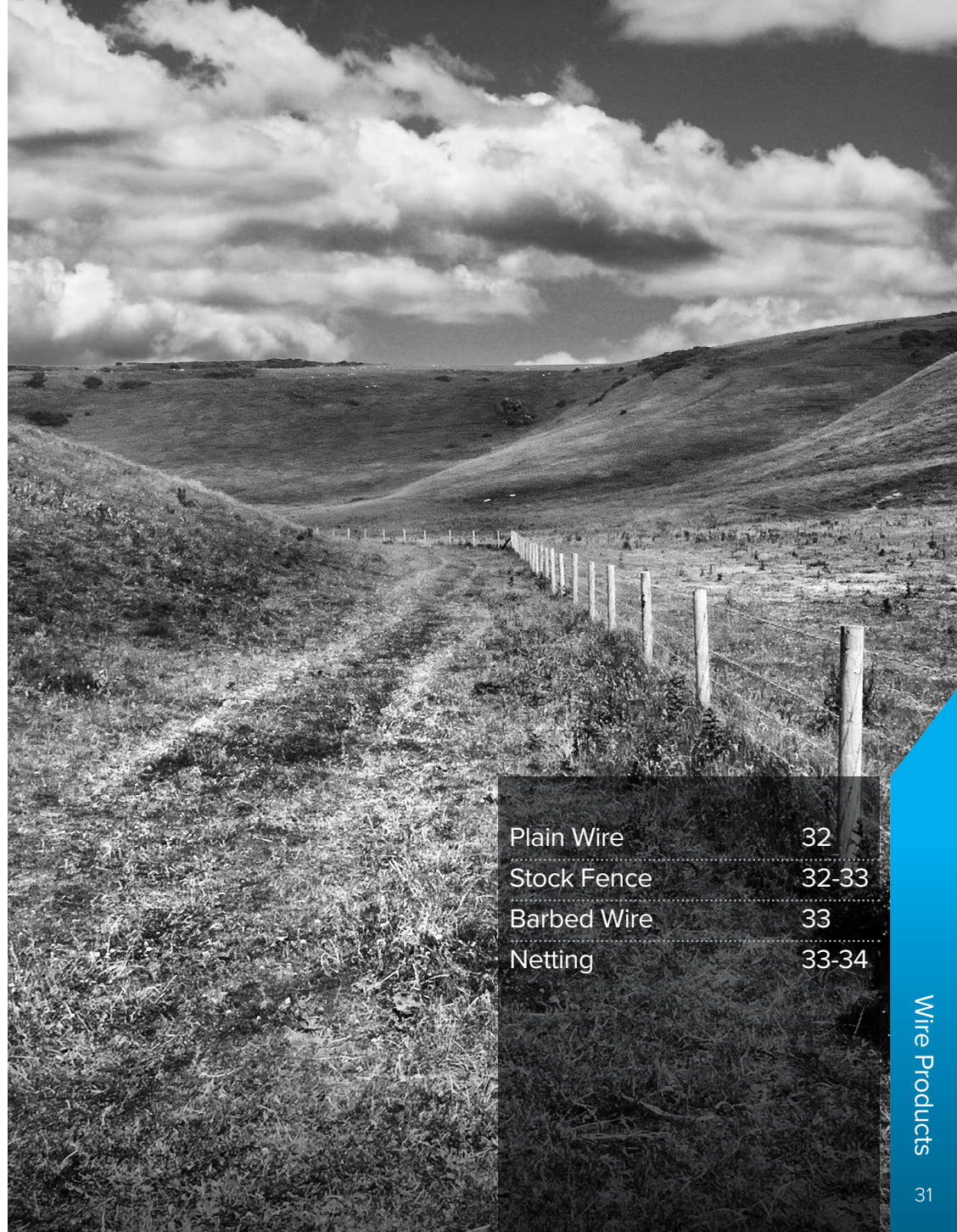

Plain Wire	32
Stock Fence	32-33
Barbed Wire	33
Netting	33-34

Plain Wire



CODE	DESCRIPTION
235 07515	1.6mm (16g) mild steel x 25kg (1590m) - Coil
235 07514	2.0mm (14g) mild steel x 25kg (1017m) - Coil
235 07522	2.5mm (12g) mild steel x 600m - On Spool
235 07523	2.5mm (12g) mild steel x 125m - On Spool
235 07516	2.5mm (12g) high tensile x 600m - On Spool
235 07518	2.5mm (12g) high tensile x 125m - On Spool
235 07521	3.15mm (10g) mild steel x 400m - On Spool
235 07524	3.15mm (10g) mild steel x 75m - On Spool
235 07517	3.15mm (10g) high tensile x 400m - On Spool
235 07520	3.15mm (10g) high tensile x 75m - On Spool
235 07506	4.0mm (8g) mild steel x 25kg (254m) - Coil
235 07507	4.0mm (8g) mild steel x 5kg (50m) - Coil
235 07504	3.15/2.24mm PVC coated x 25kg (700m) - Coil
235 07505	3.15/2.24mm PVC coated x 75m - Coil

Tie Wire



CODE	DESCRIPTION
235 07508	2.0/1.4mm PVC coated x 25 metres
235 07509	1.6mm galvanised x 25 metres

Horse Stock Fence

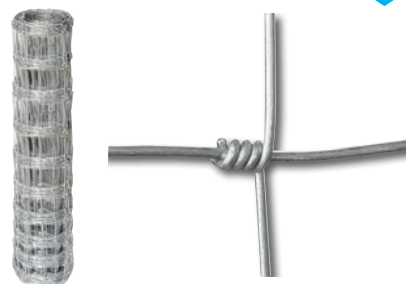

CODE	DESCRIPTION
236 05115	Horse Stock Fence HT10/107/8 (50m)
236 05116	Horse Stock Fence HT13/122/8 (50m)

Deer Stock Fence

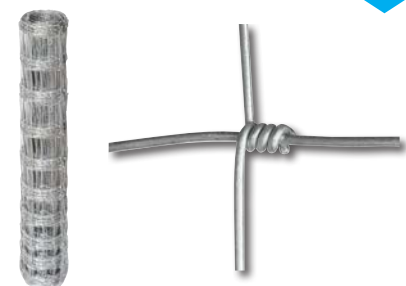

CODE	DESCRIPTION
236 04250	Deer Stock Fence LHT13/190/15 (100m)
236 04270	Deer Stock Fence HT13/190/15 (100m)
236 04260	Deer Stock Fence HT13/190/30 (100m)

Universal Dog Stock Fence



CODE	DESCRIPTION
236 05100	Stock Fence L10/120/15 (50m)

Stock Fence



CODE	DESCRIPTION
236 05110	Stock Fence L5/60/15 (50m)
236 05111	Stock Fence L8/80/15 (50m)
236 05060	Stock Fence C8/80/15 (50m)
236 05061	Stock Fence C8/80/15 (100m)
236 05070	Stock Fence HT8/80/15 (100m)
236 05112	Stock Fence B8/80/15 (50m)
236 05090	Stock Fence C8/80/22 (50m)
236 05091	Stock Fence HT8/80/22 (100m)
236 05081	Stock Fence HT8/80/15 (250m)
236 05080	Stock Fence MHT8/80/15 (100m)
236 05113	Stock Fence C6/90/30 (50m)
236 05114	Stock Fence HT6/83/22 (100m)

Barbed Wire



CODE	DESCRIPTION
236 05020	Mild Steel 2.5mm barbed wire, 2.0mm barbs every 100mm (200m)
236 05011	High Tensile H/D 2.0mm barbed wire, 1.89mm barbs every 100mm (200m)
236 05010	High Tensile 1.6mm barbed wire, 1.45mm barbs every 100mm (200m)

Rabbit Netting

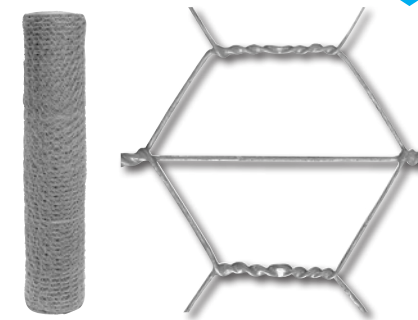

CODE	DESCRIPTION
237 05200	600mm x 31mm x 19g
237 05030	1050mm x 31mm x 19g (DIN SPEC)
237 05050	1050mm x 31mm x 18g
237 05051	1050mm x 31mm x 18g Ultra Netting (Heavy Duty)
237 05040	1200mm x 31mm x 19g
237 05220	1200mm x 31mm x 18g
237 05221	1200mm x 31mm x 18g Ultra Netting (Heavy Duty)

Pheasant Netting

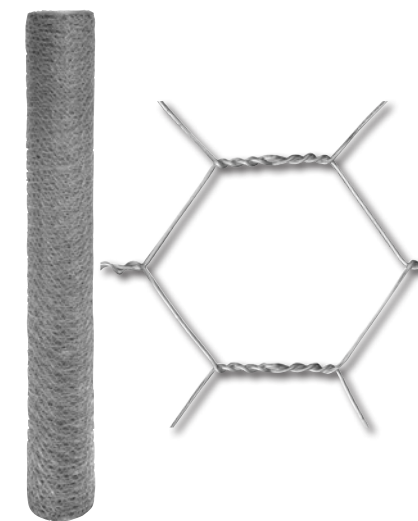

CODE	DESCRIPTION
237 05132	1500mm x 50mm x 19g
237 05131	1800mm x 38mm x 19g
237 05130	1800mm x 50mm x 19g

Chicken Netting BS443 Galvanised

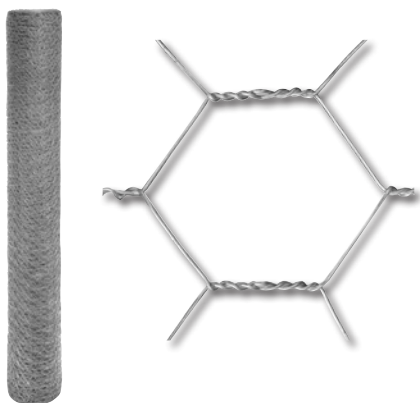

CODE	DESCRIPTION
237 05141	900mm x 50mm x 19g
237 05140	1200mm x 50mm x 19g

One Inch Netting BS443 Galvanised

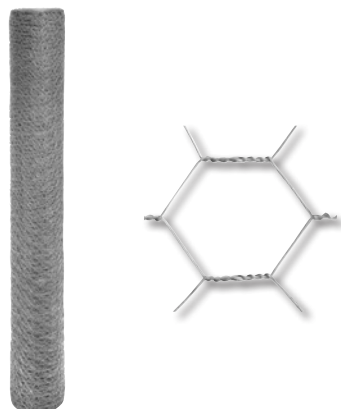

CODE	DESCRIPTION
237 05162	900mm x 25mm x 20g
237 05161	1200mm x 25mm x 20g
237 05160	1800mm x 25mm x 19g

Thatchers Netting BS443 Galvanised

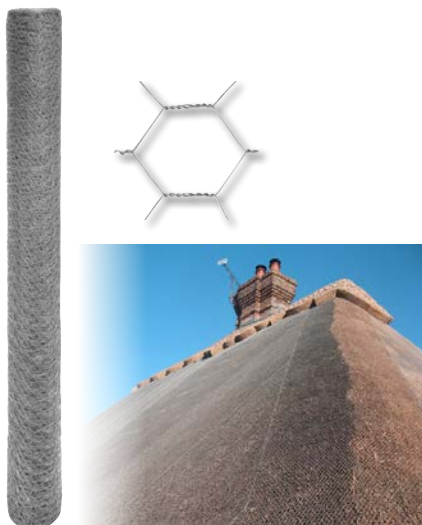

CODE	DESCRIPTION
237 05153	1200mm x 19mm x 22g

Galvanised Wire Netting (10 meter Rolls)

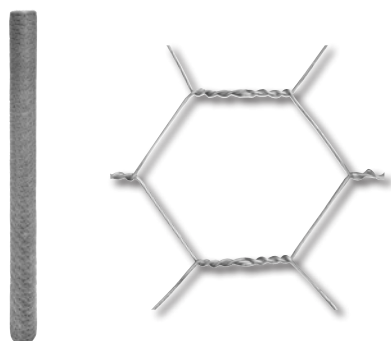

CODE	DESCRIPTION
237 05171	600mm x 25mm x 20g
237 05172	900mm x 25mm x 20g
237 05173	600mm x 13mm x 22g
237 05174	900mm x 13mm x 22g
237 05175	600mm x 50mm x 19g
237 05176	900mm x 50mm x 19g
237 05177	1200mm x 13mm x 22g
237 05178	1200mm x 25mm x 20g
237 05179	1200mm x 50mm x 19g
237 05170	1000mm x 25mm x 1.2mm (PVC Coated)



Energisers	36
Conductors	37-38
Insulators	38-39
Electrified Gates	39-40
Posts & Accessories	41-43
Electric Netting	43
Fieldguard	43-44

Portable Energiser

- Ideal for short fences or taking to events
- Designed to hang from fence or earth stake (not included)
- On/Off switch and LED Indicator
- Requires 2 x 1.5v D-Cell batteries (not included)
- 3 Year Warranty
- Includes necessary connection leads



CODE	DESCRIPTION
250 28220	Micro 3 Portable Energiser (0.07 joules = 0.2km Average run)

Solar Energisers



- Compact & robust
- Designed to give continuous operation throughout grazing season
- Powertronic technology monitors fence and only sends full power when required to optimise battery life
- Built in 12v gel battery can be topped up via mains power if required during winter months
- Comes with Fence Pulse indicator and Battery Protect function
- 3 Year Warranty
- Includes connection leads, earth stake & mains adaptor/charger

CODE	DESCRIPTION
250 28221	SP18 Solar Energiser (0.23 joules = 0.5km Average run)

Dual Power 1205



- Robust & reliable
- Very versatile, can run on a 12v battery or mains power
- Battery Protect function to ensure optimum battery life achieved
- Green Fence Pulse indicator, orange Battery Low indicator and red Battery Recharge indicator to give quick indication of fence status
- Solar compatible
- 3 Year Warranty
- Includes all necessary connection leads, earth stake & mains adaptor
- No Vegetation = 8km
- Average Vegetation = 3km
- Heavy Vegetation = 1km

CODE	DESCRIPTION
250 28100	DP1205 (1.0 joules=3km Average run)

Dual Power 1210



- Robust & reliable
- Very versatile, can run on a 12v battery or mains power
- Battery Protect function to ensure optimum battery life achieved
- Green Fence Pulse indicator, orange Battery Low indicator and red Battery Recharge indicator to give quick indication of fence status
- Solar compatible
- 3 Year Warranty
- Includes all necessary connection leads, earth stake & mains adaptor
- No Vegetation = 18km
- Average Vegetation = 6km
- Heavy Vegetation = 2km

CODE	DESCRIPTION
250 28110	DP1210 (2.2 joules=6km Average run)

Dual Power 1220



- Robust & reliable
- Very versatile, can run on a 12v battery or mains power
- Battery Protect function to ensure optimum battery life achieved
- Green Fence Pulse indicator, orange Battery Low indicator and red Battery Recharge indicator to give quick indication of fence status
- Solar compatible
- 3 Year Warranty
- Includes all necessary connection leads, earth stake & mains adaptor
- No Vegetation = 25km
- Average Vegetation = 11km
- Heavy Vegetation = 4km

CODE	DESCRIPTION
250 28170	DP1220 (3.6 joules=6km Average run)

Dual Power 1230



- Robust & reliable
- Very versatile, can run on a 12v battery or mains power
- Battery Protect function to ensure optimum battery life achieved
- Green Fence Pulse indicator, orange Battery Low indicator and red Battery Recharge indicator to give quick indication of fence status
- Solar compatible
- 3 Year Warranty
- Includes all necessary connection leads, earth stake & mains adaptor
- No Vegetation = 35km
- Average Vegetation = 15km
- Heavy Vegetation = 5km

CODE	DESCRIPTION
250 28180	DP1230 (5.0 joules=15km Average run)

Poly Rope



CODE	DESCRIPTION
257 20520	6mm x 200m Easyrope - White
257 20521	6mm x 200m Megarope - White

Poly Wire



CODE	DESCRIPTION
256 20530	250m Easyline Super Polywire
256 20531	500m Easyline Super Polywire

High Tensile Wire



CODE	DESCRIPTION
235 07516	2.5mm (12g) high tensile x 600m - On Spool
235 07518	2.5mm (12g) high tensile x 125m - On Spool

Stranded Wire



CODE	DESCRIPTION
256 19540	Galvanised, Seven Strands (200m)
256 19530	Galvanised, Seven Strands (400m)

Poly Tape - 12mm



CODE	DESCRIPTION
257 19460	12mm x 200m Easytape - White
257 20504	12mm x 200m Megatape - White

Poly Tape - 20mm



CODE	DESCRIPTION
257 20500	20mm x 200m Easytape - Green
257 20501	20mm x 200m Easytape - White
257 20505	20mm x 200m Megatape - White

Polytape - 40mm



CODE	DESCRIPTION
257 20502	40mm x 200m Easytape - Green (not pictured)
257 20503	40mm x 200m Easytape - White
257 20506	40mm x 200m Megatape - Green (not pictured)
257 20507	40mm x 200m Megatape - White

Performance Polytape - 40mm



CODE	DESCRIPTION
257 20510	40mm x 200m Maxitape - Brown (not pictured)
257 20508	40mm x 200m Maxitape - Green
257 20509	40mm x 200m Maxitape - White

Small Nail On Insulator

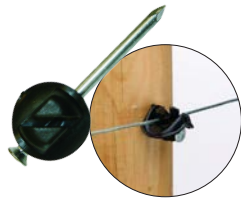

CODE	DESCRIPTION
254 20110	Small Nail on Insulator Pk100

Staple-on Insulator



CODE	DESCRIPTION
255 20140	Staple on Insulator Pk100

Standard Ring Insulator



CODE	DESCRIPTION
254 20080	Screw in Insulator - Pk25
253 20081	Screw in Insulator - Pk100

Offset Ring Insulator

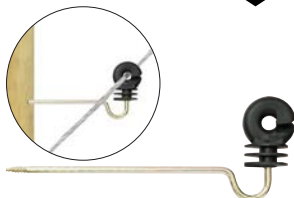

CODE	DESCRIPTION
254 19900	Offset Screw in Ring Insulator (20cm) Pk10

Heavy Duty Claw Insulator



CODE	DESCRIPTION
254 20120	Heavy Duty Claw Insulator Pk25

Clamp on Claw Insulator



CODE	DESCRIPTION
254 19950	Clamp On Claw Insulator - pk 25

Corner Pulley Insulator

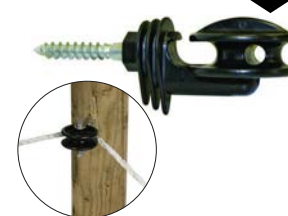

CODE	DESCRIPTION
254 20121	Corner Pulley Insulator (Pk2)

End Strainer (Egg) Insulators



CODE	DESCRIPTION
254 20050	Super Insulator Pk10 (White)
254 20060	Standard Insulator Pk10 (Black)

Nail On Tape Insulator

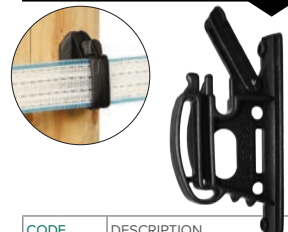

CODE	DESCRIPTION
254 19500	Standard Universal Nail On Tape insulator Pk25

Standard Tape Insulator

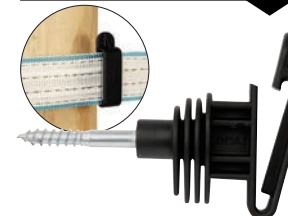

CODE	DESCRIPTION
254 19550	Screw in Insulator - Pk25
254 19549	Screw in Insulator - Pk100

Offset Tape Insulator

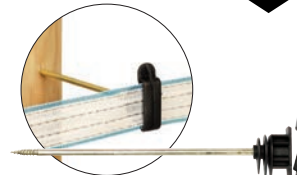

CODE	DESCRIPTION
254 19551	Offset Screw in Tape Insulator Pk10

Free Running Tape Insulator



CODE	DESCRIPTION
254 19970	Free Running Tape Insulator Pk 10

Tapelock Clamp Insulator



CODE	DESCRIPTION
254 19931	Tapelock Clamp Insulator Pk2

Buckle End Tension Insulator

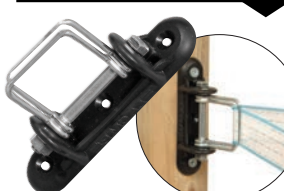

CODE	DESCRIPTION
254 20091	Buckle End Tensioner Pk2

5m Tape Gate Set with Tape

- Made from sprung galvanised wire
- Comes complete with all necessary fittings
- Extends up to 5 metres

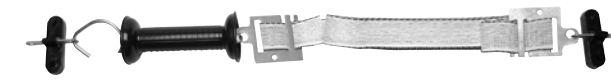

CODE	DESCRIPTION
253 19661	Tape gate set c/w 5m tape (Pk 1)

5m Spring Gate Set

- Made from sprung galvanised wire
- Comes complete with all necessary fittings
- Extends up to 5 metres



CODE	DESCRIPTION
253 19990	5m Spring Gate Set (Pk 1)

Elastic Rope Gate Set



CODE	DESCRIPTION
253 20000	Elastic Rope Gate set

Multiway Gate Anchor



CODE	DESCRIPTION
253 20045	Multiway Gate Handle Anchor - pk2

Super Gate Handle Anchor



CODE	DESCRIPTION
253 20021	Super Screw In Gate Break Post Insulator - Pk2

Standard Gate Handle



CODE	DESCRIPTION
253 20030	Standard Gate Break Handle

Super Gate Handle



CODE	DESCRIPTION
253 20035	Super Gate Break Handle

Super Horse Gate Handle



CODE	DESCRIPTION
253 20040	Super Horse Gate Break Handle

Gatelock End Clamp



CODE	DESCRIPTION
254 19930	Gatelock End Clamp Insulator - Pk2

Heavy Duty Tape End Clip



CODE	DESCRIPTION
253 19730	Heavy Duty Tape End Clip - Pk1

Undergate Cable



CODE	DESCRIPTION
256 19880	Maxi Undergate cable - 2.5mm x 25 m
256 19881	Mega Undergate cable - 2.5mm x 50m
256 19882	Mega Undergate cable - 2.5mm x 100m

Polyposts



CODE	DESCRIPTION
255 20240	Polypost 88cm (White) Pk10
255 20241	Polypost 88cm (Green) Pk10
255 20250	Polypost 140cm (White) Pk10
255 20251	Polypost 140cm (Green) Pk10

i For round timber stakes, turn to page 24

1.5v D-Cell Batteries



CODE	DESCRIPTION
252 60341	Duracell D-Cell (pack of 2)

Rechargeable Wet Battery



CODE	DESCRIPTION
252 28000	12v (75ah) Rechargeable Wet Battery

Line to Line Connector Cable



CODE	DESCRIPTION
253 19480	Line to Line Connector Cable - Max 40mm Tape

Tape Joining Buckles



CODE	DESCRIPTION
253 19815	20mm Tape Buckles - 5pk
253 19816	40mm Tape Buckles - 5pk

6v Dry Battery



CODE	DESCRIPTION
252 19760	6v PP8 Dry Battery

Earth Lead & Clip



CODE	DESCRIPTION
253 19862	Earth lead & clip

Rope Joiner



CODE	DESCRIPTION
253 19482	Rope Joiner - PK5

Split Bolt Galv Wire Joiner



CODE	DESCRIPTION
253 19840	Split Bolt Galv Wire Joiner (Pk 4)

40mm Tape Clamp



CODE	DESCRIPTION
253 19845	40mm Tape Clamp Pk1

9v Dry Batteries



CODE	DESCRIPTION
252 19740	9v 55ah Dry Battery
252 19750	9v 90ah Dry Battery
252 19751	9v 130ah dry battery

Live Fence Lead & Clip



CODE	DESCRIPTION
253 19863	Live Fence Lead & Clip

Pair of Clips with Leads



CODE	DESCRIPTION
253 19864	Pair of Crocodile Clips c/w Leads (with M8 ring ends)

Pair of Crocodile Clips



CODE	DESCRIPTION
253 19866	Pair of Red & Green Crocodile Clips

Energiser to Fence Lead



CODE	DESCRIPTION
253 19865	Energiser To Fence Lead - 40mm

Lead Out Cable



CODE	DESCRIPTION
256 19820	1.6mm core x 25m
256 19800	1.6mm core x 50m
256 19810	1.6mm core x 100m

Professional Circuit Breaker



CODE	DESCRIPTION
253 19720	Professional Circuit Breaker

Warning Signs



CODE	DESCRIPTION
253 19850	Electric fence warning sign

Digital Fence Tester



CODE	DESCRIPTION
253 19851	10kv Wireless Digital Fence Line Tester (Voltmeter)

Neon Fence Line Tester



CODE	DESCRIPTION
253 19860	10kv Neon Fence Line Tester (Voltmeter)

Earth Stake



CODE	DESCRIPTION
251 28276	Short Earth Stake 300mm
251 28240	Long Earth Stake 1000mm

Temporary Fence Reel



CODE	DESCRIPTION
255 19440	Temporary fence reel

Ring & Tape Insulator Chuck



CODE	DESCRIPTION
253 28280	Ring & Tape Insulator Chuck - Pk 1

Lightning Arrestor Kit



CODE	DESCRIPTION
253 19980	Lightening arrester

Poultry Netting



CODE	DESCRIPTION
259 17981	Electric poultry netting 50m Orange

Rabbit Netting



CODE	DESCRIPTION
259 17971	Electric rabbit netting 50m Orange
259 17972	Electric rabbit netting 50m Green

Sheep Netting



CODE	DESCRIPTION
259 17992	Electric sheep netting 50m Green
259 17991	Electric sheep netting 50m Orange

Polytape 40mm



CODE	DESCRIPTION
258 19350	Fieldguard 40mm x 100m green tape
258 19320	Fieldguard 40mm x 250m green tape
258 19290	Fieldguard 40mm x 500m green tape
258 19360	Fieldguard 40mm x 100m brown tape
258 19330	Fieldguard 40mm x 250m brown tape
258 19300	Fieldguard 40mm x 500m brown tape
258 19370	Fieldguard 40mm x 100m white tape
258 19340	Fieldguard 40mm x 250m white tape
258 19310	Fieldguard 40mm x 500m white tape

Polytape 20mm



CODE	DESCRIPTION
258 19410	Fieldguard 20mm x 250m green tape
258 19380	Fieldguard 20mm x 500m green tape
258 19420	Fieldguard 20mm x 250m brown tape
258 19390	Fieldguard 20mm x 500m brown tape
258 19430	Fieldguard 20mm x 250m white tape
258 19400	Fieldguard 20mm x 500m white tape



Special Insulator

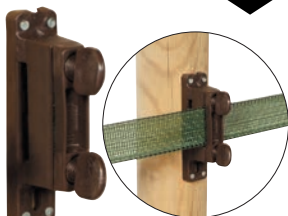

CODE	DESCRIPTION
258 19630	Fieldguard special insulator

'T' Junction Buckle

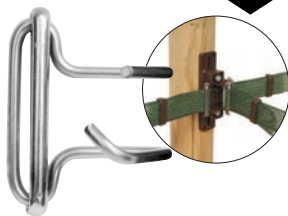

CODE	DESCRIPTION
258 19610	Fieldguard T-Junction Buckle

Contact Breaker



CODE	DESCRIPTION
254 19601	Fieldguard Contact breaker

Tensioner - Corner/End



CODE	DESCRIPTION
258 19600	Fieldguard tensioner

Connection Buckles

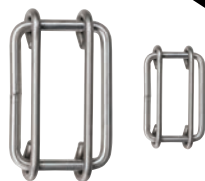

CODE	DESCRIPTION
258 19590	Fieldguard 20mm connecting buckles
258 19591	Fieldguard 40mm connecting buckles

Fibre Glass Post



CODE	DESCRIPTION
258 20260	1.7m Fieldguard glass fibre post

Insulated Gate Break Handle



CODE	DESCRIPTION
258 19570	Fieldguard gate break handle

Power Connector c/w Cable



CODE	DESCRIPTION
258 19580	Fieldguard power connector c/w cable

Extended Insulator

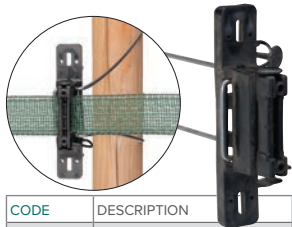

CODE	DESCRIPTION
258 19620	Fieldguard Extended Insulator

Power Connector



CODE	DESCRIPTION
258 19581	Fieldguard Power connector (pairs)



Timber Gates	46-49
Metal Gates	50-51
Gate Posts	49, 51
Gate Furniture	51-59
Bespoke Gates	60

Timber Shirefield Gates (Treated Softwood)



A well finished gate which will suit the driveway of any house, yet the pricing makes it affordable for the paddock. Standard height 3ft 7ins (1090mm) to top rail. The 3ft to 4ft sizes have only one diagonal brace. These smaller sizes are also ideal for pedestrian access and for side paths. Made from treated softwood.

CODE	DESCRIPTION
216 01170	3' Right Hand Hanging (915mm)
216 01171	3' Left Hand Hanging (915mm)
216 01172	3'6" Right Hand Hanging (1067mm)
216 01173	3'6" Left Hand Hanging (1067mm)
216 01180	4' Right Hand Hanging (1220mm)
216 01181	4' Left Hand Hanging (1220mm)
216 01190	5' Right Hand Hanging (1525mm)
216 01191	5' Left Hand Hanging (1525mm)
216 01200	6' Right Hand Hanging (1830mm)
216 01201	6' Left Hand Hanging (1830mm)
216 01210	7' Right Hand Hanging (2135mm)
216 01211	7' Left Hand Hanging (2135mm)
216 01220	8' Right Hand Hanging (2440mm)
216 01221	8' Left Hand Hanging (2440mm)
216 01230	9' Right Hand Hanging (2740mm)
216 01231	9' Left Hand Hanging (2740mm)
216 01240	10' Right Hand Hanging (3045mm)
216 01241	10' Left Hand Hanging (3045mm)
216 01250	11' Right Hand Hanging (3350mm)
216 01251	11' Left Hand Hanging (3350mm)
216 01260	12' Right Hand Hanging (3660mm)
216 01261	12' Left Hand Hanging (3660mm)
216 02140	13' Right Hand Hanging (3960mm)
216 02141	13' Left Hand Hanging (3960mm)
216 02150	14' Right Hand Hanging (4265mm)
216 02151	14' Left Hand Hanging (4265mm)

Timber Shire Gate (Iroko Hardwood)

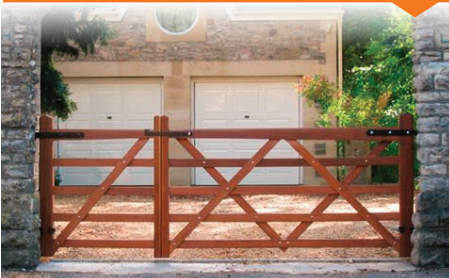

i To order only, lead time of approximately 2 weeks

CODE	DESCRIPTION
216 02900	3' Right Hand Hanging (915mm)
216 02901	3' Left Hand Hanging (915mm)
216 02910	3'6" Right Hand Hanging (1067mm)
216 02911	3'6" Left Hand Hanging (1067mm)
216 02920	4' Right Hand Hanging (1220mm)
216 02921	4' Left Hand Hanging (1220mm)
216 02930	5' Right Hand Hanging (1525mm)
216 02931	5' Left Hand Hanging (1525mm)
216 02940	6' Right Hand Hanging (1830mm)
216 02941	6' Left Hand Hanging (1830mm)
216 02950	7' Right Hand Hanging (2135mm)
216 02951	7' Left Hand Hanging (2135mm)
216 02960	8' Right Hand Hanging (2440mm)
216 02961	8' Left Hand Hanging (2440mm)
216 02970	9' Right Hand Hanging (2740mm)
216 02971	9' Left Hand Hanging (2740mm)
216 02980	10' Right Hand Hanging (3045mm)
216 02981	10' Left Hand Hanging (3045mm)
216 02990	11' Right Hand Hanging (3350mm)
216 02991	11' Left Hand Hanging (3350mm)
216 02300	12' Right Hand Hanging (3660mm)
216 02301	12' Left Hand Hanging (3660mm)

Recommended Hinges:

GATE WIDTH	RECOMMENDED HINGES
3' - 4' (0.915m - 1.22m)	12" Adjustable hinge set (page 53)
5' - 8' (1.525m - 2.44m)	18" Adjustable hinge set (page 53)
9' - 12' (2.74m - 3.66m)	24" Adjustable hinge set (page 53)

When hanging two gates as a pair it is advised that a drop bolt is fitted on each gate plus a loop over latch

Timber Estate Gate (In treated Softwood or Iroko)



i To order only, lead time of approximately 6 weeks

CODE	DESCRIPTION
216 02372	3' Right Hand Hanging (915mm)
216 02373	3' Left Hand Hanging (915mm)
216 02382	4' Right Hand Hanging (1220mm)
216 02383	4' Left Hand Hanging (1220mm)
216 02392	5' Right Hand Hanging (1525mm)
216 02393	5' Left Hand Hanging (1525mm)
216 02402	6' Right Hand Hanging (1830mm)
216 02403	6' Left Hand Hanging (1830mm)
216 02412	7' Right Hand Hanging (2135mm)
216 02413	7' Left Hand Hanging (2135mm)
216 02422	8' Right Hand Hanging (2440mm)
216 02423	8' Left Hand Hanging (2440mm)
216 02432	9' Right Hand Hanging (2740mm)
216 02433	9' Left Hand Hanging (2740mm)
216 02442	10' Right Hand Hanging (3045mm)
216 02443	10' Left Hand Hanging (3045mm)
216 02452	11' Right Hand Hanging (3350mm)
216 02453	11' Left Hand Hanging (3350mm)
216 02462	12' Right Hand Hanging (3660mm)
216 02463	12' Left Hand Hanging (3660mm)

Timber Hampton Gate



CODE	DESCRIPTION
217 01393	3' (w) x 3'6" (h) - 915mm (w) x 1067mm (h)
217 01392	3'6" (w) x 3'6" (h) - 1067mm (w) x 1067mm (h)
217 01391	4' (w) x 3'6" (h) - 1220mm (w) x 1067mm (h)
217 01390	4'6" (w) x 3'6" (h) - 1370mm (w) x 1067mm (h)
217 01382	5' (w) x 3'6" (h) - 1525mm (w) x 1067mm (h)
217 01381	5'6" (w) x 3'6" (h) - 1675mm (w) x 1067mm (h)
217 01380	6' (w) x 3'6" (h) - 1830mm (w) x 1067mm (h)

Timber Wicket Gates



CODE	DESCRIPTION
217 01362	3' (w) x 3'4" (h) - 915mm (w) x 1016mm (h)
217 01361	3'6" (w) x 3'4" (h) - 1067mm (w) x 1016mm (h)
217 01360	4' (w) x 3'4" (h) - 1220mm (w) x 1016mm (h)



A single gate hanging on the face of wooden posts

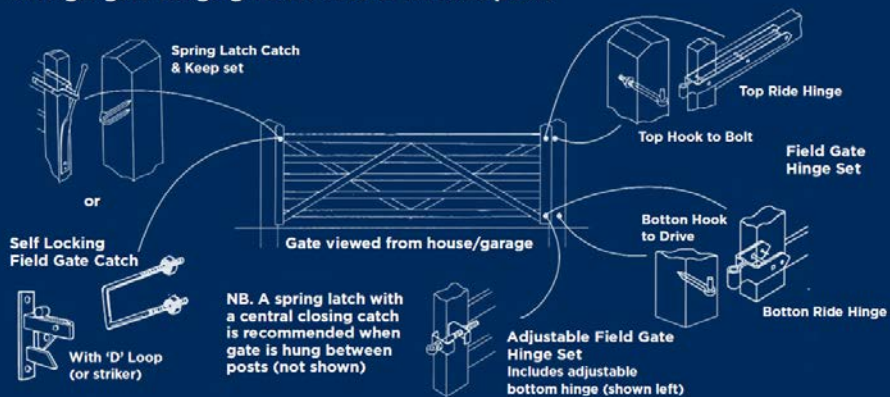

Gate hung and closing on face of post
(Most popular method)
Distance between posts = gate length minus 75mm. Open one way only 180°

Gate hung and closing between post
Distance between posts = gate length plus 215mm. Open both ways 110°



A pair of gates hanging between stone pillars or walls

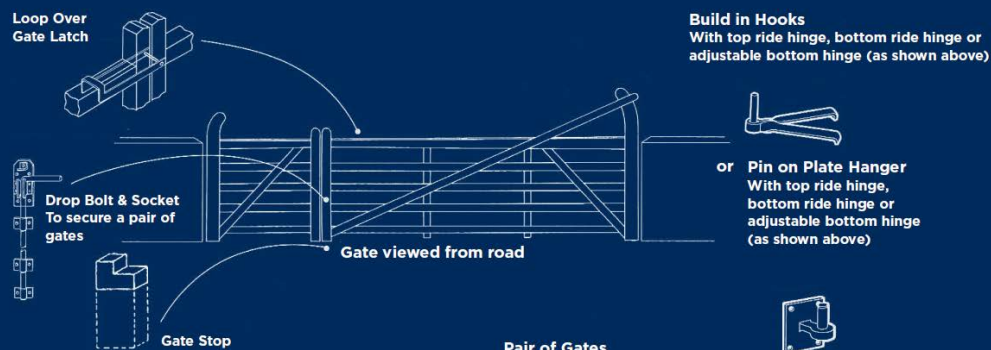

Pair of gates hung and closing on face of posts
Distance between posts = combined gate lengths minus 75mm or just over. Open one way only 180°

Pair of gates hung and closing between posts
Distance between posts = combined gate lengths plus 236mm or just over. Open both ways only 110°



Timber Palisade Gates



CODE	DESCRIPTION
217 01280	2'10" (h) x 3' (w) Pointed Top - 865mm (h) x 915mm (w)
217 01270	3'10" (h) x 3' (w) Pointed Top - 1150mm (h) x 915mm (w)
217 01281	2'10" (h) x 3' (w) Round Top - 865mm (h) x 915mm (w)
217 01271	3'10" (h) x 3' (w) Round Top - 1150mm (h) x 915mm (w)

i Bespoke size timber palisade gates available, please call us on 01264 366211

Timber Panel Gates



CODE	DESCRIPTION
217 01320	2'10" (h) x 3' (w) - 865mm (h) x 915mm (w)
217 01330	3'10" (h) x 3' (w) - 1150mm (h) x 915mm (w)
217 01340	4'10" (h) x 3' (w) - 1473mm (h) x 915mm (w)
217 01160	5'10" (h) x 3' (w) - 1778mm (h) x 915mm (w)

Closeboard Gates



CODE	DESCRIPTION
217 01290	2'10" (h) x 3' (w) - 865mm (h) x 915mm (w)
217 01300	3'10" (h) x 3' (w) - 1150mm (h) x 915mm (w)
217 01310	4'10" (h) x 3' (w) - 1473mm (h) x 915mm (w)
217 01150	5'10" (h) x 3' (w) - 1778mm (h) x 915mm (w)
217 01152	5'10" (h) x 4' (w) - 1778mm (h) x 1200mm (w)

i Bespoke size closeboard gates available, please call us on 01264 366211

Timber Gate Posts - Pressure Treated



CODE	DESCRIPTION
221 1110	7' x 5" x 5" - 2.1m x 125mm x 125mm
221 11083	8' x 5" x 5" - 2.4m x 125mm x 125mm
221 11100	7' x 6" x 6" - 2.1m x 150mm x 150mm
221 11082	8' x 6" x 6" - 2.4m x 150mm x 150mm
221 11077	9' x 6" x 6" - 2.7m x 150mm x 150mm
221 11090	7' x 7" x 7" - 2.1m x 175mm x 175mm
221 11081	8' x 7" x 7" - 2.4m x 175mm x 175mm
221 11078	9' x 7" x 7" - 2.7m x 175mm x 175mm
221 11080	8' x 8" x 8" - 2.4m x 200mm x 200mm
221 11079	9' x 8" x 8" - 2.7m x 200mm x 200mm

i Oak gate posts available to order, please call us on 01264 366211



Ashfield 7 Rail Metal Gates

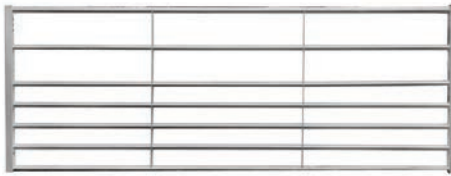

SPECIFICATIONS: 3'9" (1143mm) High
 Hanging style 50mm x 50mm channel section. Slam style 50mm x 25mm box section. Top and bottom rails 43mm OD steel tube
 Intermediate rails 29mm OD steel tube. Bracings 50mm x 5mm MS flat
 Hinge eyes 20mm adjustable. Fastenings D Loop or 20mm dia. spring Bolt
 FINISH: Hot dip galvanised after manufacture to BS729
 NOTE: Bespoke size gates are available (16'0" (4880mm) is maximum length available)

CODE	DESCRIPTION
219 02191	3' (915mm) c/w Spring Bolt
219 02190	3' (915mm) c/w D Loop
219 02181	4' (1220mm) c/w Spring Bolt
219 02180	4' (1220mm) c/w D Loop
219 04131	5' (1525mm) c/w Spring Bolt
219 04130	5' (1525mm) c/w D Loop
219 04121	6' (1830mm) c/w Spring Bolt
219 04120	6' (1830mm) c/w D Loop
219 04111	7' (2135mm) c/w Spring Bolt
219 04110	7' (2135mm) c/w D Loop
219 04101	8' (2440mm) c/w Spring Bolt
219 04100	8' (2440mm) c/w D Loop
219 04091	9' (2740mm) c/w Spring Bolt
219 04090	9' (2740mm) c/w D Loop
219 04081	10' (3045mm) c/w Spring Bolt
219 04080	10' (3045mm) c/w D Loop
219 04082	10' Pairs
219 04071	11' (3350mm) c/w Spring Bolt
219 04070	11' (3350mm) c/w D Loop
219 04061	12' (3660mm) c/w Spring Bolt
219 04060	12' (3660mm) c/w D Loop
219 04062	12' Pairs
219 13121	13' (3960mm) c/w Spring Bolt
219 13120	13' (3960mm) c/w D Loop
219 13131	14' (4265mm) c/w Spring Bolt
219 13130	14' (4265mm) c/w D Loop
219 13141	15' (4570mm) c/w Spring Bolt
219 13140	15' (4570mm) c/w D Loop
219 13142	15' Pairs
219 13151	16' (4875mm) c/w Spring Bolt
219 13150	16' (4875mm) c/w D Loop
219 13152	16' Pairs

Half Mesh Metal Gates



SPECIFICATIONS: 3'9" High
 Hanging style 50mm x 25mm channel section
 Slam style 50mm x 25mm box section
 Top and bottom rails 44.5mm OD steel tube
 Intermediate rails 30mm OD steel tube
 Bracings 40mm x 4mm MS flat
 Hinge eyes 20mm adjustable
 Fastenings 20mm dia. spring load bolt or D loop.
 FINISH: Hot dip galvanised after manufacture to BS729
 NOTE: Odd size gates are available (16' 0" is maximum length available)

CODE	DESCRIPTION
219 04081	10' (3045mm) c/w Spring Bolt
219 04061	12' (3660mm) c/w Spring Bolt
219 13141	15' (4570mm) c/w Spring Bolt
219 13151	16' (4875mm) c/w Spring Bolt

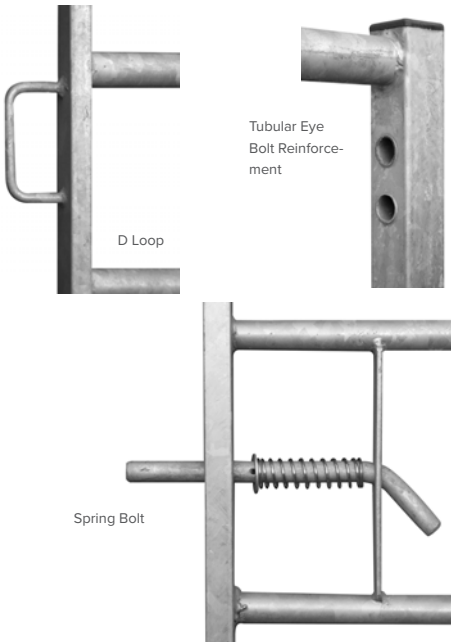

i For ZEDLOCKS and other security products, turn to page 71

Metal Barrier Gate



i Barrier gates & posts available
 Please call 01264 366 211

Galvanised Gate Posts



CODE	DESCRIPTION
220 13000	88.9mm dia (3½") Hanging Post c/w Hooks
220 13010	88.9mm dia (3½") Hanging Post c/w inverted Hooks
220 13020	88.9mm dia (3½") Slamming Post c/w Slot
220 13030	88.9mm dia (3½") Slamming Post c/w Auto Catch
220 13040	88.9mm dia (3½") Slamming Post c/w Dual Slot & Spigot
220 13050	88.9mm dia (3½") Ground Socket c/w Lid
220 13060	114.3mm dia (4½") Hanging Post c/w Hooks
220 13070	114.3mm dia (4½") Hanging Post c/w inverted Hooks
220 13080	114.3mm dia (4½") Slamming Post c/w Slot
220 13090	114.3mm dia (4½") Slamming Post c/w Auto Catch
220 13100	114.3mm dia (4½") Slamming Post c/w Dual Slot & Spigot
220 13110	114.3mm dia (4½") Ground Socket c/w Lid

Galvanised Adjustable Hinge Set



CODE	DESCRIPTION
223 15347	Adjustable bottom hinge set - for 3" gates, comprising: 12" double strap hinge, adjustable gate eye bracket, hook to bolt, hook to drive and fixings.
223 15346	Adjustable bottom hinge set - for 3" gates, comprising: 18" double strap hinge, adjustable gate eye bracket, two hooks on 4" x 4" plates and fixings
223 15348	Adjustable bottom hinge set - for 3" gates, comprising: 24" double strap hinge, adjustable gate eye bracket, two hooks on 4" x 4" plates and fixings
223 15349	Adjustable bottom hinge set - for 3" gates, comprising: 24" double strap hinge, adjustable gate eye bracket, hook to bolt, hook to drive and fixings.

i See page 46 for guide on how to determine hinge length by gate width

Standard Hinge Set

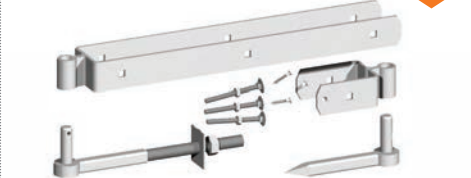

CODE	DESCRIPTION
223 15351	Standard hinge set - for 3" gates, comprising: 24" double strap hinge, 5" double strap hinge, hook to bolt, hook to drive & fixings



Rising Hinge Set



CODE	DESCRIPTION
223 15350	Rising hinge set - for 3" gates, comprising 24" double strap hinge, hook to bottom band, rocker plate and fixings

hook & Bolt (Square Shank)

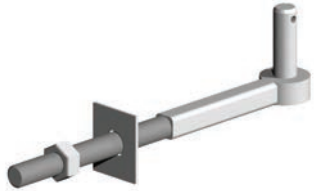

CODE	DESCRIPTION
223 15243	13" Hook to Bolt - square shank - 20mm pin5

hook & Bolt (Round Shank)



CODE	DESCRIPTION
223 15244	8" Gate hanger to bolt - 20mm pin
223 15245	10" Gate hanger to bolt - 20mm pin
223 15246	12" Gate hanger to bolt - 20mm pin

Hook to Drive



CODE	DESCRIPTION
223 15247	8" Hooks to drive - 20mm pin

Build in Hook



CODE	DESCRIPTION
223 15248	Build in hooks - 20mm pin

Hook on Square Plate



CODE	DESCRIPTION
223 15249	Hooks 4" x 4" plates - 20mm pin

Adjustable Hook on Square Plate

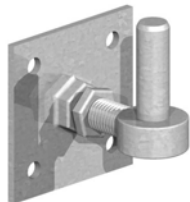

CODE	DESCRIPTION
223 15250	Adjustable Hook on 4" x 4" plate - 20mm pin

Hook on Narrow Plate



CODE	DESCRIPTION
223 15282	Hook on narrow plate - 20mm pin

Hook to Weld



CODE	DESCRIPTION
223 15255	Gate Hooks to weld - Flat Base 19mm
223 15278	Gate Hooks to weld - Flat Base 22mm
223 15256	Gate Hooks to weld - Radius Base 19mm
223 15279	Gate Hooks to weld - Radius Base 22mm

Eyes to Weld

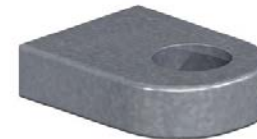

CODE	DESCRIPTION
223 15257	Gate Eyes to weld - Flat Base 19mm
223 15258	Gate Eyes to weld - Flat Base 22mm
223 15280	Gate Eyes to weld - Radius Base 19mm
223 15281	Gate Eyes to weld - Radius Base 22mm

Double Strap Hinge



CODE	DESCRIPTION
223 15262	5" Double Strap Hinge - To Suit 20mm Pin
223 15261	12" Double Strap Hinge - To Suit 20mm Pin
223 15260	18" Double Strap Hinge - To Suit 20mm Pin
223 15259	24" Double Strap Hinge - To Suit 20mm Pin

Adjustable Bottom Hinge



CODE	DESCRIPTION
223 15263	Adjustable Bottom Hinge

Offset Double Strap Hinge



CODE	DESCRIPTION
223 16260	24" Double Strap Hinge - With offset eye on corner
223 16270	5" Double Strap Hinge - With offset eye on corner
223 16280	24" Double Strap Hinge - With straight eye on corner
223 16290	5" Double Strap Hinge - With straight eye on corner

Rising Hinge

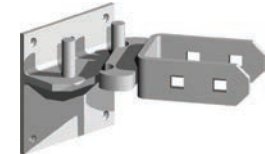

CODE	DESCRIPTION
223 16240	Rising Hinge - Double strap bands and rocker plate

Gate Eyes & Nuts



CODE	DESCRIPTION
223 15166	6" x 1" (25mm) Gate Eye c/w 2 Nuts
223 15167	6" x 1 1/4" (31mm) Gate Eye c/w 2 Nuts Heavy Duty
223 15145	4" x 3/4" (19mm) Gate Eye c/w 2 Nuts
223 15146	6" x 3/4" (19mm) Gate Eye c/w 2 Nuts
223 15147	10" x 3/4" (19mm) Gate Eye c/w 2 Nuts

Straight Hooks & Bands



CODE	DESCRIPTION
223 15264	12" Straight Hooks & Bands
223 15265	14" Straight Hooks & Bands
223 15266	18" Straight Hooks & Bands
223 15267	20" Straight Hooks & Bands
223 15268	24" Straight Hooks & Bands
223 15269	30" Straight Hooks & Bands
223 15284	12" Straight Hooks & Bands - Black
223 15285	14" Straight Hooks & Bands - Black
223 15286	18" Straight Hooks & Bands - Black
223 15287	20" Straight Hooks & Bands - Black
223 15288	24" Straight Hooks & Bands - Black
223 15299	30" Straight Hooks & Bands - Black

Tee Hinges



CODE	DESCRIPTION
223 15130	4" Tee Hinges (Zinc coated)
223 15131	6" Tee Hinges (Zinc coated)
223 15132	12" Tee Hinges (galvanised)
223 15133	12" Tee Hinges (black)
223 15134	14" Tee Hinges (galvanised)
223 15135	14" Tee Hinges (black)
223 15136	18" Tee Hinges (galvanised)
223 15137	18" Tee Hinges (black)
223 15138	20" Tee Hinges (galvanised)
223 15139	24" Tee Hinges (galvanised)

Cranked Hooks & Bands



CODE	DESCRIPTION
223 15270	12" Cranked Hooks & Bands
223 15271	14" Cranked Hooks & Bands
223 15272	18" Cranked Hooks & Bands
223 15273	20" Cranked Hooks & Bands
223 15274	24" Cranked Hooks & Bands
223 15275	30" Cranked Hooks & Bands
223 15291	12" Cranked Hooks & Bands - Black
223 15292	14" Cranked Hooks & Bands - Black
223 15293	18" Cranked Hooks & Bands - Black
223 15294	20" Cranked Hooks & Bands - Black
223 15295	24" Cranked Hooks & Bands - Black
223 15296	30" Cranked Hooks & Bands - Black

Heavy Reversible Hinges



CODE	DESCRIPTION
223 15140	12" Heavy Reversible Hinges
223 15141	18" Heavy Reversible Hinges
223 15142	20" Heavy Reversible Hinges
223 15143	24" Heavy Reversible Hinges
223 15144	30" Heavy Reversible Hinges
223 15180	12" Heavy Reversible Hinges - Black
223 15181	18" Heavy Reversible Hinges - Black
223 15182	20" Heavy Reversible Hinges - Black
223 15183	24" Heavy Reversible Hinges - Black
223 15184	30" Heavy Reversible Hinges - Black

Adjustable Hooks & Bands



CODE	DESCRIPTION
223 15377	18" Adjustable Hook & Bands (Galvanised) - pairs
223 15390	18" Adjustable Hook & Bands (Black) - pairs
223 15378	24" Adjustable Hook & Bands (Galvanised) - pairs
223 15400	24" Adjustable Hook & Bands (Black) - pairs
223 15379	30" Adjustable Hook & Bands (Galvanised) - pairs
223 15410	30" Adjustable Hook & Bands (Black) - pairs

Spring Catch Set c/w Fastenings



CODE	DESCRIPTION
223 15148	Spring catch & keep set - for 3" gates, comprising Spring Fastener, Catch, Keep & Fastening

Staple Catch



CODE	DESCRIPTION
223 15150	Staple Catch - Drive In
223 15151	Staple Catch - On Plate

Gate Fastening Set (for pair of gates)



CODE	DESCRIPTION
223 15671	Pair of Gates Fastener Set comprising: 14" Throw Over Loop, 18" Drop Bolt and Fixings

Throw Over Loop



CODE	DESCRIPTION
223 15170	12" x 2" Throw Over Loop
223 15152	6" Throw Over Loop
223 15153	14" Throw Over Loop

Throw Over Loop (light duty)



CODE	DESCRIPTION
223 16020	Throw Over Loop For Metal Gates - Light Pattern

Throw Over Loop (heavy duty)



CODE	DESCRIPTION
223 16010	Throw Over Loop For Metal Gates - Heavy Duty Pattern
223 16011	Padlockable peg for heavy duty throw over loop (above)

Auto Catch & Striker Set



CODE	DESCRIPTION
223 15168	Auto Catch & Striker Set

Striker



CODE	DESCRIPTION
223 15157	Cranked Striker

Auto Catch (large)



CODE	DESCRIPTION
223 15154	Auto Catch - Large

D-Loop Striker



CODE	DESCRIPTION
223 15158	D-Loop Striker (Galvanised)

Auto Catch (hunting type)



CODE	DESCRIPTION
223 15155	Hunting type locking gate catch

Central Receiving Plate



CODE	DESCRIPTION
223 15159	Central Receiving Plate

Auto Catch & Striker



CODE	DESCRIPTION
223 15171	Auto Catch & Striker - Black
223 15156	Auto Catch and Striker - Galvanised

Gate Return Spring



CODE	DESCRIPTION
223 15510	8" Gate Return Spring BZP
223 15511	10" Gate Return Spring BZP

Suffolk Latch



CODE	DESCRIPTION
223 15165	Suffolk Latch
223 15172	Suffolk Latch - Black

Ring Latch



CODE	DESCRIPTION
223 15160	Ring Latch 6" Galvanised
223 15161	Ring Latch 6" Black

Kick Over Latch



CODE	DESCRIPTION
223 15500	Kick Over Latch

Mortice Latch

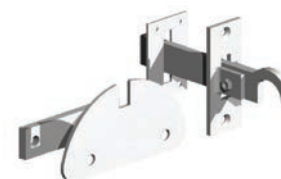

CODE	DESCRIPTION
223 15162	Mortice Latch
223 15163	Mortice Ring Latch (Not illustrated)

Kenham Latch



CODE	DESCRIPTION
223 15169	Kenham Latch

Spring Loaded Animal Bolt



CODE	DESCRIPTION
223 15520	Zinc Plated, Spring Loaded Animal Bolt

Oval Padbolt



CODE	DESCRIPTION
223 15530	Oval Padbolt

Brentons Padbolt



CODE	DESCRIPTION
223 15540	4" Brentons Padbolt Galvanised
223 15541	4" Brentons Padbolt Black
223 15550	6" Brentons Padbolt Galvanised
223 15551	6" Brentons Padbolt Black
223 15560	8" Brentons Padbolt Galvanised
223 15570	10" Brentons Padbolt Galvanised

Cabin Hooks



CODE	DESCRIPTION
223 15580	4" Cabin Hook
223 15590	6" Cabin Hook
223 15600	10" Cabin Hook
223 15610	12" Cabin Hook

Safety Gate Hook & Eye



CODE	DESCRIPTION
223 15650	Safety Gate Hook & Eye

New Zealand Gate Fastener



CODE	DESCRIPTION
223 15651	Complete with 1000mm chain (Galvanised)

Light Hasp & Staple



CODE	DESCRIPTION
223 15620	Light Hasp & Staple 4½"
223 15621	Light Hasp & Staple 6"

Heavy Hasp & Staple



CODE	DESCRIPTION
223 15630	Heavy Hasp & Staple 8"

Heavy Swivel Locking Hasp & Staple



CODE	DESCRIPTION
223 15631	Heavy Swivel Locking Bar 8"

Heavy Hasp & Staple (vertical pattern)



CODE	DESCRIPTION
223 15640	Heavy Hasp & Staple - Vertical Pattern

Monkey Tail Bolt

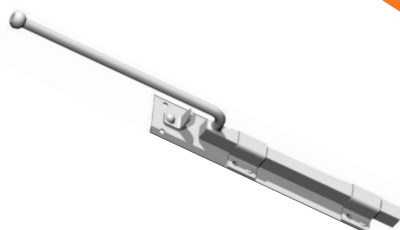

CODE	DESCRIPTION
223 15700	18" Monkey Tail Bolt

Garage Drop Bolt



CODE	DESCRIPTION
223 15669	12" Garage Drop Bolt
223 15670	18" Garage Drop Bolt
223 15668	18" Garage Drop Bolt - Black
223 15690	24" Garage Drop Bolt

Locking Garage Drop Bolt



CODE	DESCRIPTION
223 15660	18" Locking Garage Drop Bolt

Gravity Gate Catch (to concrete)



CODE	DESCRIPTION
223 15710	Gravity Gate Catch - To Concrete, Medium Pattern
223 15730	Gravity Gate Catch - To Concrete, Heavy Pattern

Gravity Gate Catch (to screw)



CODE	DESCRIPTION
223 15720	Gravity Gate Catch - To Screw, Heavy Pattern

Pair of Gates Centre Stop



CODE	DESCRIPTION
223 15740	Gate Centre Stop (a)
223 15376	Pyramid Receiver Socket (b)

Spring Loaded Gate Wheel



CODE	DESCRIPTION
223 15801	Standard Spring Loaded Gate Wheel



Here at ATF, we can manufacture bespoke gates to your exact requirements.

Please contact our friendly sales team on:
01264 366 211 or email:
sales@atfsuppliesuk.com



Chainlink	62
Razor Wire	62
Welded Mesh	62-63
Angle Iron Posts	63
Concrete Chainlink Posts	64
Hoarding Materials	64
Barrier Fencing & Tape	64

Chainlink (50mm Mesh Size x 25 Metre Rolls)



CODE	DESCRIPTION
238 04180	0.9m high c/w 2.5mm dia core
238 04190	1.2m high c/w 2.5mm dia core
238 04140	1.8m high c/w 2.5mm dia core

CODE	DESCRIPTION
238 04020	0.9m high c/w 3.0mm dia core
238 04030	1.2m high c/w 3.0mm dia core
238 04040	1.8m high c/w 3.0mm dia core

Chainlink (50mm Mesh Size x 25 Metre Rolls)



CODE	DESCRIPTION
238 04200	0.9m high c/w 3.1mm/2.1mm PVC coated Green or Zinc Core
238 04210	1.2m high c/w 3.1mm/2.1mm PVC coated Green or Zinc Core
238 04170	1.8m high c/w 3.1mm/2.1mm PVC coated Green or Zinc Core

Razor Wire



CODE	DESCRIPTION
239 04235	455mm Coil Diameter - 10m (!) (c/w warning sign)

Heavy Duty Welded Mesh (2.5mm dia wire)

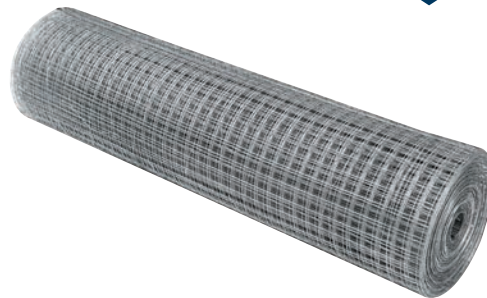

CODE	DESCRIPTION
240 04220	900mm high 50mm x 50mm x 25m rolls (Galv)
240 04221	1200mm high 50mm x 50mm x 25m rolls (Galv)
240 04230	1800mm high 50mm x 50mm x 25m rolls (Galv)

Heavy Duty Welded Mesh (2.5/3.0mm Wire)

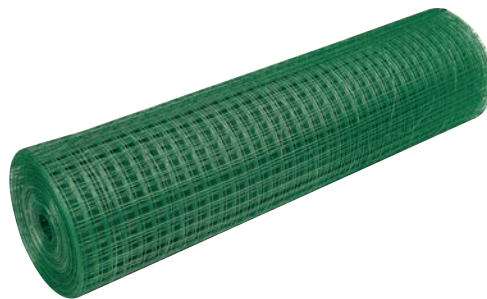

CODE	DESCRIPTION
240 04240	900mm high 50mm x 50mm x 25m rolls (PVC)
240 04241	1200mm high 50mm x 50mm x 25m rolls (PVC)
240 04231	1800mm high 50mm x 50mm x 25m rolls (PVC)

Light Duty Welded Mesh

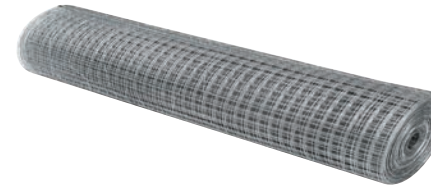

CODE	DESCRIPTION
240 04050	900mm x 25mm x 25mm 16g (30m Roll Length)
240 04150	900mm x 25mm x 25mm 16g (6m Roll Length)
240 04051	1200mm x 25mm x 25mm 16g (30m Roll Length)
240 04052	900mm x 25mm x 25mm 19g (30m Roll Length)
240 04151	900mm x 25mm x 25mm 19g (6m Roll Length)
240 04053	900mm x 13mm x 25mm 16g (30m Roll Length)
240 04160	900mm x 13mm x 25mm 16g (6m Roll Length)
240 04054	900mm x 13mm x 25mm 19g (30m Roll Length)
240 04161	900mm x 13mm x 25mm 19g (6m Roll Length)
240 04055	900mm x 13mm x 13mm 19g (30m Roll Length)
240 04162	900mm x 13mm x 13mm 19g (6m Roll Length)

RSA Intermediate Posts - Black Painted



CODE	DESCRIPTION
214 07010	1.5m x 40 x 40 x 5 RSA inter post for 0.9m chainlink
214 07011	1.8m x 40 x 40 x 5 RSA inter post for 1.2m chainlink
214 07012	2.4m x 40 x 40 x 5 RSA inter post for 1.8m chainlink

RSA End Straining Posts - Black Painted



CODE	DESCRIPTION
214 07020	1.5m x 50 x 50 x 5 RSA end post for 0.9m chainlink c/w strut & fittings
214 07021	1.8m x 50 x 50 x 5 RSA end post for 1.2m chainlink c/w strut & fittings
214 07022	2.4m x 50 x 50 x 5 RSA end post for 1.8m chainlink c/w strut & fittings

RSA Corner Posts - Black Painted



CODE	DESCRIPTION
214 07030	1.5m x 50 x 50 x 5 RSA corner post for 0.9m chainlink c/w struts & fittings
214 07031	1.8m x 50 x 50 x 5 RSA corner post for 1.2m chainlink c/w struts & fittings
214 07032	2.4m x 50 x 50 x 5 RSA corner post for 1.8m chainlink c/w struts & fittings

RSA Two Way Strainers - Black Painted

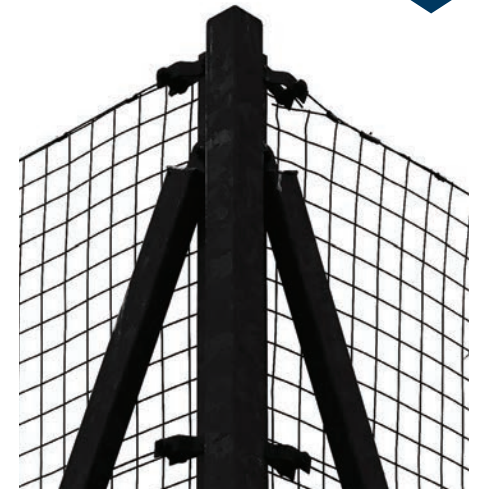

CODE	DESCRIPTION
214 07040	1.5m x 50 x 50 x 5 RSA 2-way post for 0.9m chainlink c/w struts & fittings
214 07041	1.8m x 50 x 50 x 5 RSA 2-way post for 1.2m chainlink c/w struts & fittings
214 07042	2.4m x 50 x 50 x 5 RSA 2-way post for 1.8m chainlink c/w struts & fittings

Concrete Intermediate Posts



CODE	DESCRIPTION
215 12510	1.45m x 100mm > 75mm (4'9" x 4" > 3")
215 12520	1.905m x 100mm > 75mm (6'3" x 4" > 3")
215 12530	2.515m x 100mm > 75mm (8'3" x 4" > 3")

Concrete End Posts



CODE	DESCRIPTION
215 12511	1.45m x 100mm x 100mm (4'9" x 4" x 4")
215 12521	1.905m x 100mm x 100mm (6'3" x 4" x 4")
215 12531	2.515m x 100mm x 100mm (8'3" x 4" x 4")

Concrete Two Way Posts



CODE	DESCRIPTION
215 12512	1.45m x 100mm x 100mm (4'9" x 4" x 4")
215 12522	1.905m x 100mm x 100mm (6'3" x 4" x 4")
215 12532	2.515m x 100mm x 100mm (8'3" x 4" x 4")

Concrete Corner Posts



CODE	DESCRIPTION
215 12513	1.45m x 100mm x 100mm (4'9" x 4" x 4")
215 12523	1.905m x 100mm x 100mm (6'3" x 4" x 4")
215 12533	2.515m x 100mm x 100mm (8'3" x 4" x 4")

Concrete Strut



CODE	DESCRIPTION
215 12514	1.5m x 75mm x 75mm (5' x 3" x 3") - For 1.45m Posts
215 12524	1.83m x 75mm x 75mm (6' x 3" x 3") - For 1.905m Posts
215 12534	2.59m x 100mm x 85mm (8'6" x 4" x 3½") - For 2.515m Posts

Pinewood Ply



CODE	DESCRIPTION
205 08101	2.44m x 1.22m x 12mm WBP Ply (8' x 4' x ½")
205 08100	2.44m x 1.22m x 18mm WBP Ply (8' x 4' x ¾")

Timber Posts



CODE	DESCRIPTION
205 09050	3.0m x 100mm x 100mm (10' x 4" x 4")
205 09080	3.6m x 100mm x 100mm (12' x 4" x 4")

Timber Rail



CODE	DESCRIPTION
204 11580	Treated Rail 4.8m x 75mm x 47mm (16' x 3" x 2")
204 11570	Treated Rail 4.8m x 100mm x 47mm (16' x 4" x 2")

Barrier Fencing & Tape



CODE	DESCRIPTION
212 30050	Orange Barrier Fencing
212 17540	Red/White Zebra Tape 75mm x 500m
212 30040	Fencing Pin Solid Hook 54"

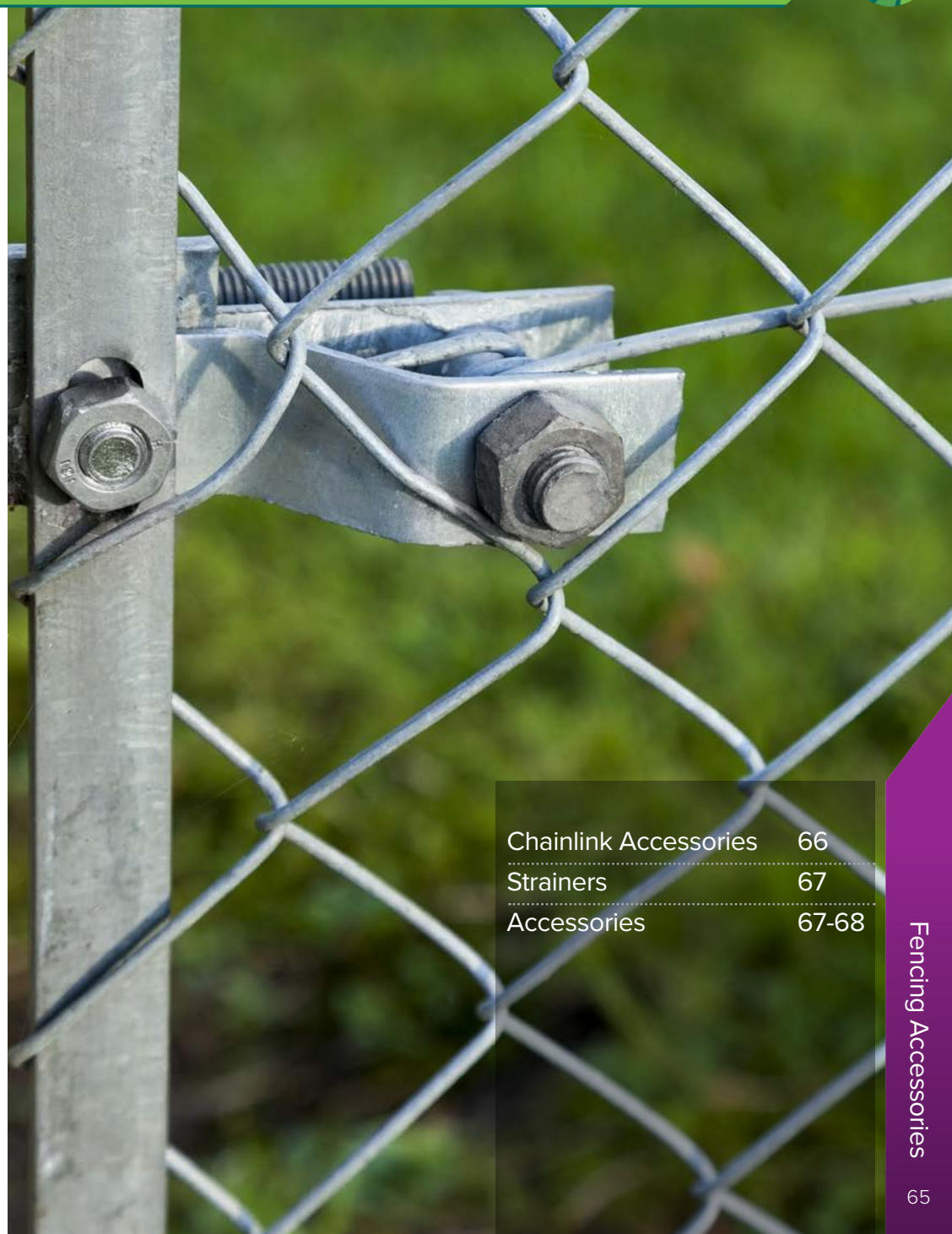

Chainlink Accessories	66
Strainers	67
Accessories	67-68

Angle Cleats

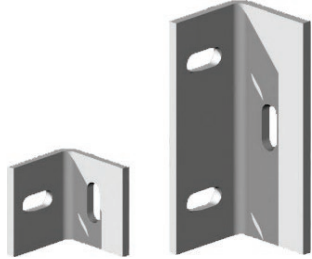

CODE	DESCRIPTION
228 16410	Angle cleats, galvanised 50mm x 50mm x 6mm
228 16411	Angle cleats, galvanised 40mm x 40mm x 5mm
228 16420	Angle cleats, galvanised 150mm x 50mm x 6mm

Galvanised Barbed Wire Extenders



CODE	DESCRIPTION
228 16530	Cranked welded barbed wire extenders 375mm
228 16531	Cranked flat barbed wire extenders 450mm

Loop Adapter



CODE	DESCRIPTION
228 16421	Loop adapter, galvanised 3/8" (9.5mm)

Hairpin Staples



CODE	DESCRIPTION
228 16430	Hairpin staples, galvanised 2 1/2" (65mm)
228 16431	Hairpin staples, galvanised 7" (175mm)

Stretcher Bar



CODE	DESCRIPTION
228 27070	Stretcher bar, galvanised 900mm x 5mm 2 holes
228 27080	Stretcher bar, galvanised 1200mm x 5mm 3 holes
228 27090	Stretcher bar, galvanised 1800mm x 5mm 3 holes

Eyebolts - Folded



CODE	DESCRIPTION
228 17390	Eyebolts - folded c/w 2 nuts & washers BZP 8" x 3/8"
228 17400	Eyebolts - folded c/w 2 nuts & washers BZP 10" x 3/8"
228 17410	Eyebolts - folded c/w 2 nuts & washers BZP 12" x 3/8"

Eyebolts - Welded



CODE	DESCRIPTION
228 17420	Eyebolts - welded c/w 2 nuts & washers BZP 8" x 3/8"
228 17430	Eyebolts - welded c/w 2 nuts & washers BZP 10" x 3/8"
228 17440	Eyebolts - welded c/w 2 nuts & washers BZP 12" x 3/8"

Barrel Strainers



CODE	DESCRIPTION
225 16432	1/4" (6 mm) - galvanised
225 16440	5/6" (8 mm) - galvanised
225 16441	3/8" (10 mm) - galvanised
225 16442	1/2" (12 mm) - galvanised

Permanent In Line Strainers

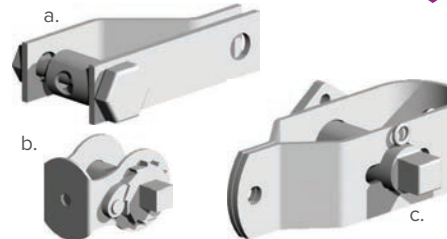

CODE	DESCRIPTION
225 16490	Ferrule winders - galvanised (a)
225 16500	Heavy duty ratchet winder - galvanised (b)
225 16520	Large raddiseur winder - galvanised (c)

Permanent Wire Strainers

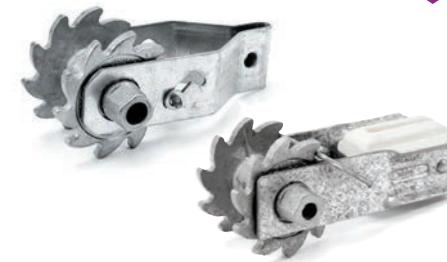

CODE	DESCRIPTION
225 16450	Permanent wire strainers
225 16451	Insulated permanent wire strainer
225 16452	Tightening handle for above

Metal Arris Rail Brackets



CODE	DESCRIPTION
226 16580	Arris rail repair bracket
226 16590	Arris rail mortice bracket

Handed Arris Rail Brackets

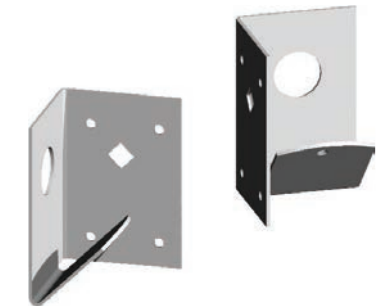

CODE	DESCRIPTION
226 16480	Bolt on arris rail repair bracket L/H
226 16481	Bolt on arris rail repair bracket R/H



Shaped Bird Mouth Straps



CODE	DESCRIPTION
226 16620	Shaped bird mouth straps 2"
226 16621	Shaped bird mouth straps 3"

i For standard bird mouth straps, turn to page 28

Twin Pin Cleats



CODE	DESCRIPTION
226 16630	Twin pin cleats - for 6" (150mm) gravel boards
226 16633	Twin pin cleats - for 12" (300mm) gravel boards

Gravel Boards Brackets



CODE	DESCRIPTION
226 16631	Gravel Board Bracket 150mm x 50mm (6" x 2")-suitable to fit concrete gravel boards to timber posts
226 16632	Gravel Board Bracket 150mm x 25mm (6" x 1")



Padlocks	70
Security Chains	71
Wire Rope & Accessories	71
Welded Chain	72
Chain Accessories	72

Combination Block Padlock



CODE	DESCRIPTION
229 15362	Squire 85mm Combination Block Padlock

Stronghold Padlock



CODE	DESCRIPTION
229 15345	Squire Stronghold Combination Padlock

Combination Padlock



CODE	DESCRIPTION
229 15367	Squire 50mm Combination Padlock
229 15352	Squire 60mm Combination Padlock

Brass Block Padlock



CODE	DESCRIPTION
229 15363	Squire 90mm Brass Padlock
229 15360	Squire 70mm Brass Padlock

Standard Brass Padlock



CODE	DESCRIPTION
229 15353	Squire Brass Padlock 40mm (LP9)
229 15354	Squire Brass Padlock 50mm (LP10)
229 15355	Squire Brass Padlock 60mm (LP60)
229 15358	Squire Keyed Alike Brass Padlock 50mm (LP10)
229 15359	Squire Keyed Alike Brass Padlock 60mm (LP60)

Long Shackle Brass Padlock



CODE	DESCRIPTION
229 15357	Squire Long Shackle Brass Padlock 50mm (LP10/2.5)

Armoured Block Padlock



CODE	DESCRIPTION
229 15364	Squire 80mm Armoured Steel Block Padlock

Open Shackle Padlock



CODE	DESCRIPTION
229 15366	Squire 50mm Open Shackle Padlock (SS50P5)

Disc Padlock



CODE	DESCRIPTION
229 15361	Squire Disc Padlock 70mm DCL1

Old English Padlock



CODE	DESCRIPTION
229 15356	Squire 68.5mm Old English Padlock 660

Alarmed Padlock



CODE	DESCRIPTION
229 67114	Faithful 70mm Padlock with Security Alarm

ZEDLOCK - For Metal Gates



CODE	DESCRIPTION
229 67087	Multi Lever ZED Lock 70mm Throw
229 67088	Multi Lever ZED Lock 70mm Throw - Keyed Alike

i These are also available for use with timber gates, please enquire

Security Chain



CODE	DESCRIPTION
229 67085	Squire Security Chain 6.5mm x 900mm

High Security Chains



CODE	DESCRIPTION
229 67082	Alloy Steel Hardened Chain, Black Sleeve 10mm x 915mm (G3)
229 67083	Alloy Steel Hardened Chain, Black Sleeve 10mm x 1200mm (G4)
229 67080	Alloy Steel Hardened Chain, Black Sleeve 8mm x 915mm (J3)
229 67081	Alloy Steel Hardened Chain, Black Sleeve 10mm x 1200mm (J4)

Wire Rope



CODE	DESCRIPTION
230 67062	1/8" (3.0 mm) 155 kg
230 67063	3/16" (5.0 mm) 385 kg
230 67064	1/4" (6.0 mm) 635 kg

Commercial Thimble



CODE	DESCRIPTION
230 67050	1" x 1/8" (25 x 3 mm) - BZP Finish
230 67051	1 1/4" x 3/16" (32 x 5 mm) - BZP Finish
230 67052	1 1/2" x 1/4" (38 x 6 mm) - BZP Finish

Wire Rope Grip



CODE	DESCRIPTION
230 67030	1/8" (3 mm) - Galvanised Finish
230 67031	3/16" (5 mm) - Galvanised Finish
230 67032	1/4" (6 mm) - Galvanised Finish
230 67033	5/16" (8 mm) - Galvanised Finish
230 67034	3/8" (10 mm) - Galvanised Finish
230 67036	1/2" (13 mm) - Galvanised Finish

Welded Chain



CODE	DESCRIPTION
229 67020	3 Gauge x 21 links per feet - HDG Gauge Finish, 50 kg Gauge Max Load
229 67021	4 Gauge x 26 links per feet - HDG Gauge Finish, 85 kg Gauge Max Load
229 67022	5 Gauge x 28 links per feet - HDG Gauge Finish, 130 kg Gauge Max Load
229 67023	6 Gauge x 33 links per feet - HDG Gauge Finish, 140 kg Gauge Max Load
229 67024	6.5 Gauge x 36 links per feet - HDG Gauge Finish, 150 kg Gauge Max Load

Dee Shackle



CODE	DESCRIPTION
229 67000	3/16" (5 mm)
229 67001	1/4" (6 mm)
229 67002	5/16 " (8 mm)
229 67003	3/8 "(10 mm)
229 67004	7/16 "(11 mm)
229 67005	1/2" (13 mm)
229 67006	7/16 "(16 mm)

Quick Repair Link



CODE	DESCRIPTION
229 67010	3 mm
229 67011	4 mm
229 67012	5 mm
229 67013	6 mm
229 67014	7 mm



Woodscrews	74-75
Bolts, Nuts & Washers	75-76
Hammer & Frame Fixings	76
Wall Plugs	77
Anchor Fixings	77
Nails	77
Staples	78
Vine Eyes & Hooks	78

No 8 Performance Woodscrews



- Pozi drive with double countersink to reduce breakage and assist countersinking
- Corrosion resistant with milling thread to reduce torque
- Type 17 cut point reduces splitting and need of pre-drilling
- Boxes come with FREE Pozi driver bit

CODE	DESCRIPTION
231 14208	4.0 x 25mm (8 x 1") - Pack 25
231 14450	4.0 x 25mm (8 x 1") - Box 200
231 14209	4.0 x 35mm (8 x 1 1/4") - Pack 25
231 14451	4.0 x 40mm (8 x 1 1/2") - Box 200
231 14452	4.0 x 50mm (8 x 2") - Box 200
231 14453	4.0 x 60mm (8 x 2 1/2") - Box 200
231 14211	4.0 x 70mm (8 x 3") - Pack 25
231 14454	4.0 x 70mm (8 x 3") - Box 100

No 10 Performance Woodscrews



- Pozi drive with double countersink to reduce breakage and assist countersinking
- Corrosion resistant with milling thread to reduce torque
- Type 17 cut point reduces splitting and need of pre-drilling
- Boxes come with FREE Pozi driver bit

CODE	DESCRIPTION
231 14212	5.0 x 40mm (10 x 1 1/2") - Pack 25
231 14455	5.0 x 40mm (10 x 1 1/2") - Box 200
231 14456	5.0 x 50mm (10 x 2") - Box 200
231 14213	5.0 x 60mm (10 x 2 1/2") - Pack 25
231 14457	5.0 x 70mm (10 x 3") - Box 100
231 14214	5.0 x 100mm (10 x 4") - Pack 10
231 14458	5.0 x 100mm (10 x 4") - Box 100

No 12 Performance Woodscrews



- Pozi drive with double countersink to reduce breakage and assist countersinking
- Corrosion resistant with milling thread to reduce torque
- Type 17 cut point reduces splitting and need of pre-drilling
- Boxes come with FREE Pozi driver bit

CODE	DESCRIPTION
231 14215	6.0 x 90mm (12 x 3 3/4") - Pack 10
231 14216	6.0 x 150mm (12 x 6") - Pack 10

Hex Head Coachscrews BZP



CODE	DESCRIPTION
231 14222	M6 x 60mm (Box200)
231 15012	M6 x 65mm (Pack 10)
231 14225	M6 x 90mm (Box100)
231 15013	M6 x 90mm (Pack 4)
231 14227	M8 x 50mm (Box100)
231 15014	M8 x 50mm (Pack 6)
231 14230	M8 x 90mm (Box100)
231 15015	M8 x 90mm (Pack 4)
231 14231	M8 x 100mm (Box50)
231 15016	M8 x 100mm (Pack 4)
231 14233	M8 x 150mm (Box50)
231 15017	M8 x 150mm (Pack 4)
231 14235	M10 x 50mm (Box100)
231 15018	M10 x 50mm (Pack 4)
231 14237	M10 x 70mm (Box50)
231 15019	M10 x 75mm (Pack 4)
231 14238	M10 x 80mm (Box50)
231 14240	M10 x 100mm (Box50)
231 15020	M10 x 100mm (Pack 4)
231 14242	M10 x 130mm (Box25)
231 15021	M10 x 130mm (Pack 4)
231 14244	M10 x 150mm (Box50)
231 15022	M10 x 150mm (Pack 4)
231 14245	M10 x 160mm (Box50)
231 14246	M10 x 180mm (Box25)
231 15023	M10 x 180mm (Pack 4)
231 14247	M10 x 200mm (Box25)
231 15024	M10 x 200mm (Pack 4)
231 14250	M12 x 70mm (Box50)

Hex Head Screws



CODE	DESCRIPTION
232 14506	90mm - Pk 25
232 14520	90mm - Bx 100
232 14507	140mm - Pk 25
232 14521	140mm - Bx 100
232 14508	190mm - Pk 10
232 14522	190mm - Box 100
232 14509	240mm - Pk 10
232 14523	240mm - Box 100
232 14505	Spare Driver Bit

Deck Screws



■ Square drive head - c/w free screw-driver bit

CODE	DESCRIPTION
232 14510	40mm (1 1/2") - Bx 200
232 14511	50mm(2") - Bx 200
232 14512	63mm (2 1/2") - Box 200
232 14515	63mm (2 1/2") - Bucket 2000
232 14514	75mm (3") - Box 200
232 14516	90mm (3 1/2") - Bx 200
232 14513	Spare Driver Bit

i PLEASE NOTE, boxes of cup square hex fixings include the bolts and nuts, smaller packs of cup square hex include bolts, nuts and washers.

M6 Cup Square Hex



CODE	DESCRIPTION
231 15025	M6 x 40mm - Pack 10
231 14336	M6 x 40mm - Box 200
231 15026	M6 x 65mm - Pack 8
231 14338	M6 x 65mm - Box 100
231 14339	M6 x 75mm - Box 100
231 14341	M6 x 100mm - Box 100
231 14342	M6 x 110mm - Box 100
231 15027	M6 x 130mm - Pack 4
231 14343	M6 x 130mm - Box 100

M8 Cup Square Hex



CODE	DESCRIPTION
231 14346	M8 x 40mm - Box 100
231 15028	M8 x 50mm - Pack 6
231 14347	M8 x 50mm - Box 100
231 15029	M8 x 65mm - Pack 6
231 14348	M8 x 65mm - Box 100
231 14350	M8 x 90mm - Box 100
231 15030	M8 x 100mm - Pack 4
231 14351	M8 x 100mm - Box 100
231 14352	M8 x 110mm - Box 50
231 15031	M8 x 130mm - Pack 4
231 14353	M8 x 130mm - Box 50
231 15032	M8 x 150mm - Pack 4
231 14354	M8 x 150mm - Box 50
231 14355	M8 x 160mm - Box 50
231 15033	M8 x 180mm - Pack 4
231 14356	M8 x 180mm - Box 50
231 15034	M8 x 200mm - Pack 4
231 14357	M8 x 200mm - Box 50

M10 Cup Square Hex



CODE	DESCRIPTION
231 14358	M10 x 50mm - Box 50
231 15035	M10 x 50mm - Pack 4
231 14359	M10 x 65mm - Box 50
231 15036	M10 x 65mm - Pack 4
231 14363	M10 x 80mm - Box 50
231 15037	M10 x 80mm - Pack 4
231 14360	M10 x 90mm - Box 50
231 14361	M10 x 100mm - Box 50
231 15038	M10 x 100mm - Pack 4
231 14362	M10 x 110mm - Box 50
231 15039	M10 x 110mm - Pack 4
231 14364	M10 x 130mm - Box 25
231 15040	M10 x 130mm - Pack 2
231 14366	M10 x 150mm - Box 25
231 15041	M10 x 150mm - Pack 2
231 14367	M10 x 160mm - Box 25
231 15042	M10 x 160mm - Pack 2
231 14368	M10 x 180mm - Box 25
231 15043	M10 x 180mm - Pack 2
231 14369	M10 x 200mm - Box 25
231 15044	M10 x 200mm - Pack 2
231 14371	M10 x 220mm - Box 25
231 15045	M10 x 220mm - Pack 2
231 14372	M10 x 240mm - Box 25
231 14373	M10 x 260mm - Box 25
231 14374	M10 x 300mm - Box 20

M12 Cup Square Hex



CODE	DESCRIPTION
231 14375	M12 x 50mm - Box 50
231 14376	M12 x 65mm - Box 50
231 14377	M12 x 75mm - Box 50
231 15046	M12 x 75mm - Pack 4
231 14378	M12 x 90mm - Box 50
231 14379	M12 x 100mm - Box 50
231 15047	M12 x 100mm - Pack 2
231 14385	M12 x 200mm - Box 25
231 15048	M12 x 200mm - Pack 2



M6 Mushroom Head Roofing Bolts & Nuts - BZP



CODE	DESCRIPTION
231 15049	M6 x 25mm - Pack 12
231 14401	M6 x 25mm - Box 200
231 15050	M6 x 50mm - Pack 8
231 15051	M6 x 80mm - Pack 6
231 14404	M6 x 80mm - Box 100
231 14407	M6 x 120mm - Box 50
231 14408	M6 x 140mm - Box 50

M8 Mushroom Head Roofing Bolts & Nuts - BZP



CODE	DESCRIPTION
231 14400	M8 x 25mm - Box 100
231 14413	M8 x 30mm - Box 100
231 14414	M8 x 40mm - Box 100
231 14415	M8 x 50mm - Box 100
231 15052	M8 x 50mm - Pack 6
231 15053	M8 x 100mm - Pack 4
231 14419	M8 x 100mm - Box 50
231 14421	M8 x 140mm - Box 50
231 14422	M8 x 160mm - Box 50
231 14423	M8 x 180mm - Box 50
231 15054	M8 x 180mm - Pack 4
231 14424	M8 x 200mm - Box 50
231 14425	M8 x 220mm - Box 50

M10 Mushroom Head Roofing Bolts & Nuts - BZP



CODE	DESCRIPTION
231 14431	M10 x 30mm - Box 50
231 14432	M10 x 40mm - Box 50
231 14433	M10 x 50mm - Box 50
231 14435	M10 x 70mm - Box 25
231 14436	M10 x 100mm - Box 25
231 14437	M10 x 120mm - Box 25

Steel Penny Washers BZP

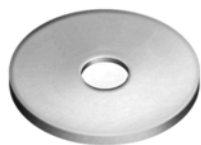

CODE	DESCRIPTION
231 15003	M6 x 25mm (Pack 20)
231 14172	M6 x 25mm (Box 100)
231 14165	M8 x 25mm (Pack 20)
231 14179	M8 x 25mm (Box 100)

Steel Washers BZP



CODE	DESCRIPTION
231 15004	M6 (Pack 30)
231 15005	M8 (Pack 30)
231 14173	M8 (Box 200)
231 15006	M10 (Pack 20)
231 14174	M10 (Box 50)
231 15007	M12 (Pack 20)
231 14175	M12 (Box 100)
231 15008	M20 (Pack 2)

Square Plate Washers BZP



CODE	DESCRIPTION
231 15010	M10 (Pack 10)
231 14176	M10 (Box 100)
231 15011	M12 (Pack 10)
231 14177	M12 (Box 50)

Steel Hex Full Nuts BZP



CODE	DESCRIPTION
231 15000	M8 - Pack 10
231 15001	M10 - Pack 10
231 15002	M12 - Pack 8

Shield Anchors Bolt Projecting Type



CODE	DESCRIPTION
231 15055	M6 x 60mm (Pack 4)
231 15056	M8 x 25mm (Pack 4)
231 15057	M10 x 15mm (Pack 4)

Shield Anchors Loose Bolt Type



CODE	DESCRIPTION
231 15058	M10 x 50mm (Pack 4)
231 15059	M10 x 75mm (Pack 4)

Hammer & Frame Fixings



CODE	DESCRIPTION
231 15060	M8 x 120 (Pack 10)
231 15061	M10 x 100 (Pack 10)
231 15062	M10 x 120 (Pack 10)

Thunder Bolt Self Tapping Anchor Fixing



CODE	DESCRIPTION
231 15063	M8 x 75mm (Pack 4)
231 15064	M8 x 100mm (Pack 4)
231 15065	M10 x 100mm (Pack 4)
231 15066	M10 x 150mm (Pack 4)

Galvanised Nails



CODE	DESCRIPTION
231 14300	40mm x 2.5kg (Approx. 1600)
233 14020	40mm x 5kg (Approx. 3200)
233 14012	40mm x 25kg (Approx. 16,000)
231 14301	50mm x 2.5kg (Approx. 1100)
233 14022	50mm x 5kg (Approx. 2200)
233 14011	50mm x 25kg (Approx. 11,000)
231 14302	65mm x 2.5kg (Approx. 660)
233 14024	65mm x 5kg (Approx. 1320)
233 14010	65mm x 25kg (Approx. 6,600)
231 14303	75mm x 2.5kg (Approx. 360)
233 14026	75mm x 5kg (Approx. 720)
233 14009	75mm x 25kg (Approx. 3,600)
231 14304	100mm x 2.5kg (Approx. 190)
233 14028	100mm x 5kg (Approx. 380)
233 14008	100mm x 25kg (Approx. 1,900)
231 14305	125mm x 2.5kg (Approx. 100)
233 14030	125mm x 5kg (Approx. 200)
233 14007	125mm x 25kg (Approx. 1,000)
231 14306	150mm x 2.5kg (Approx. 70)
233 14032	150mm x 5kg (Approx. 140)
233 14006	150mm x 25kg (Approx. 700)

Galvanised Clout Nails



CODE	DESCRIPTION
233 14112a	25kg Clout Nails 25mm
233 14113b	2.5kg Clout Nails 30mm
233 14113a	25kg Clout Nails 30mm

Nail Fire



CODE	DESCRIPTION
233 14104	Nail Fire Collated Ring Shank Nails 50 x 2.9mm - EZP Galv (bx 3000 inc. fuel cells)
233 14103	Nail Fire Collated Ring Shank Nails 65 x 2.9mm - Galv (bx 3000 inc. fuel cells)
233 14102	Nail Fire Collated Ring Shank Nails 76 x 3.1mm - Galv (bx 2000 inc. fuel cells)
233 14101	Nail Fire Collated Smooth Shank Nails 90 x 3.1mm - Galv (bx 2000 inc. fuel cells)
233 14100	Nail Fire Fuel Cell

i For cordless gas powered nail guns, turn to page 103

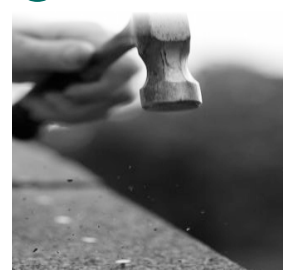

Spring Head Roofing Nails



CODE	DESCRIPTION
233 14013b	65mm x 1kg
233 14013a	65mm x 10kg

Plastic Fixing Plugs



CODE	DESCRIPTION
231 14797	Yellow
231 14798	Red
231 14799	Brown

Nylon Wall Plugs



CODE	DESCRIPTION
231 14802	M10 x 50
231 14803	M12 x 60
231 14804	M14 x 80

Galvanised Staples



CODE	DESCRIPTION
231 14307	15mm x 1kg
231 14005	15mm x 25kg
231 14309	25mm x 2.5kg
233 14034	25mm x 5kg
233 14004	25mm x 25kg
231 14310	30mm x 2.5kg
233 14036	30mm x 5kg
233 14003	30mm x 25kg
231 14411	40mm x 2.5kg
233 14038	40mm x 5kg
233 14002	40mm x 25kg
231 14412	50mm x 2.5kg
233 14040	50mm x 5kg
233 14001	50mm x 25kg

Galvanised Barbed Staples



CODE	DESCRIPTION
233 14107	40mm x 5kg Barbed Staples
233 14000	40mm x 20kg Barbed Staples

Fencing Staples - For Staple Gun



CODE	DESCRIPTION
231 14316	33mm Staples (2700 Staples + 3 Fuel Cells)
231 14317	40mm Staples (2100 Staples + 2 Fuel Cells)

i For cordless gas powered staple guns, turn to page 103

Vine Eyes to Drive



CODE	DESCRIPTION
234 14812	75mm Vine Eyes to drive
234 14813	100mm Vine Eyes to drive

Vine Eyes to Screw



CODE	DESCRIPTION
234 14810	75mm Vine Eyes to screw
234 14811	100mm Vine Eyes to screw

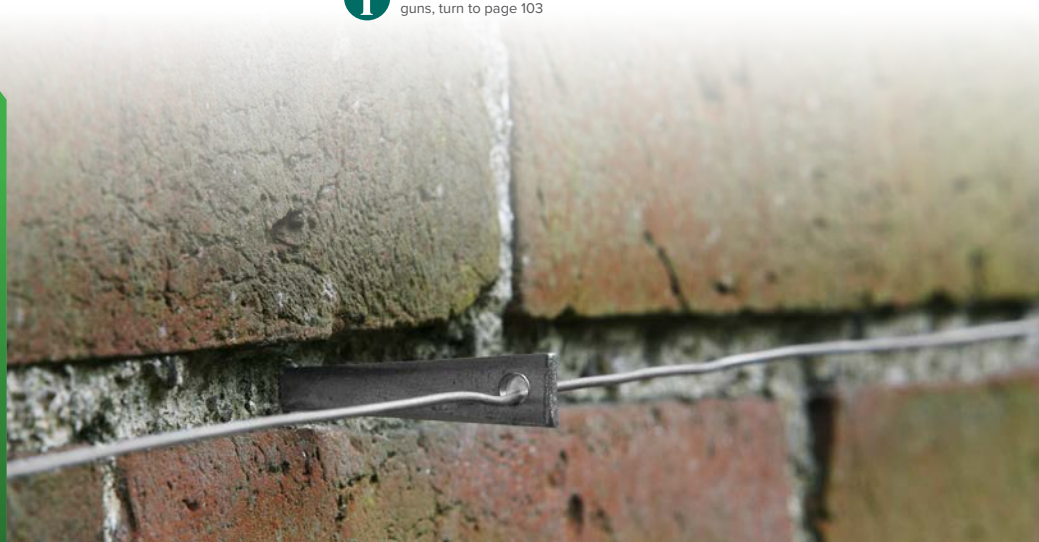

Tree Supports	80
Tree Shelters	80-81
Tying & Strapping	81-82
Watering Equipment	83
Root Directors	83
Anchoring Products	84

Tree Stakes



CODE	DESCRIPTION
201 12020	Treated Round Stakes Pointed 5'6" x 2" - 3"
201 12030	Treated Round Stakes Pointed 6' x 2" - 3"
201 12040	Treated Round Stakes Pointed 8' x 2" - 3"

i For our range of machined round stakes, please turn to page 23

Shelter Stakes

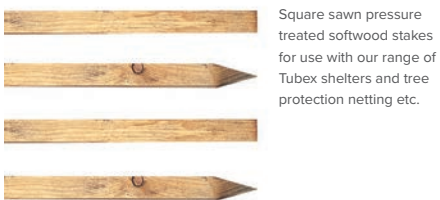

Square sawn pressure treated softwood stakes for use with our range of Tubex shelters and tree protection netting etc.

CODE	DESCRIPTION
116 11361	Shelter Stakes 0.75m x 25mm x 25mm
116 11351	Shelter Stakes 0.9m x 25mm x 25mm
116 11341	Shelter Stakes 0.75m x 32mm x 32mm
116 11331	Shelter Stakes 0.9m x 32mm x 32mm
116 11321	Shelter Stakes 1.2m x 32mm x 32mm
116 11311	Shelter Stakes 1.35m x 32mm x 32mm
116 11301	Shelter Stakes 1.5m x 32mm x 32mm

Canes



High quality for the support of spiral guards.

CODE	DESCRIPTION
117 40070	Canes 3' x 9-11lbs / 100

The Standard



The world's most popular tree shelters. Suitable for a wide range of planting stock.

• PACK OF 100

CODE	DESCRIPTION
104 40032	Tubex Standard 0.6h x 73mm-105mm dia
104 40031	Tubex Standard 0.75h x 73mm-105mm dia
104 40030	Tubex Standard 1.2h x 73mm-105mm dia

The Standard Plus



The world's most popular tree shelters. Suitable for a wide range of planting stock.

• PACK OF 60

CODE	DESCRIPTION
104 40022	Tubex Standard + 1.2m x 80mm-120mm dia-60pk
104 40021	Tubex Standard + 1.5h x 80mm-120mm dia -60 pk
104 40020	Tubex Standard + 1.8m x 80mm-120mm dia-60 pk

The Shrub Shelter



Sturdy protection & improved survival rates for multi-stemmed planting stock.

• PACK OF 28

CODE	DESCRIPTION
104 40052	Tubex Shrub Shelter 0.6h 130mm-160mm dia
104 40053	Tubex Shrub Shelter 0.75h 130mm-160mm dia

Brown Spiral Guards



An economical guard that provides good value protection

• PACK OF 250

CODE	DESCRIPTION
105 39400	Spiral Guard 45cm h 38mm dia Brown
105 39420	Spiral Guard 60cm h 38mm dia Brown
105 39440	Spiral Guard 60cm h 50mm dia Brown

Clear Spiral Guards



An economical guard that provides good value protection

• PACK OF 250

CODE	DESCRIPTION
105 39410	Spiral Guard 45cm h 38mm dia Clear
105 39430	Spiral Guard 60cm h 38mm dia Clear
105 39450	Spiral Guard 60cm h 50mm dia Clear

Net Guard



Unobtrusive protection for forestry or landscape planting durable pre-cut protection with anti abrasion rim.

• PACK OF 100

CODE	DESCRIPTION
104 40090	0.6m (h) 15cm (dia)
104 40091	0.6m (h) 25cm (dia)
104 40095	Tie sets for Net Guards

Green Net Guard Rolls



Net guard in 50 metre rolls is used where larger diameter guards are required

CODE	DESCRIPTION
104 40093	Mesh Tree Guard 0.6m x 50m green/HDPE
104 30100	Mesh Tree Guard 1.2m x 50m green/HDPE

Welded Mesh Tree Guards



Made of galvanised welded mesh, these guards offer an effective & long lasting solution for amenity & urban planting.

CODE	DESCRIPTION
107 40041	Welded Mesh Guards 4' x 12" dia - Galvanised
107 40040	Welded Mesh Guards 6' x 12" dia - Galvanised

Welded Steel Tree Guards



For park & pedestrian areas - available in two finishes.

CODE	DESCRIPTION
108 40160	Tree Protector 1.8m h x 400mm dia galv (C750)
108 40161	Tree Protector 1.8m h x 400mm dia black (C751)

Buckle Tree Ties

One of the most popular tree ties used for speed and efficiency - includes hoop & collar



CODE	DESCRIPTION
112 30290	30cm x 1.25cm (C238)
112 30740	38cm x 2.5cm (C201)
112 30750	45cm x 2.5cm (C202)
112 30760	60cm x 2.5cm (C203)
112 30780	60cm x 3.85cm (C263)

Super Soft Ties



CODE	DESCRIPTION
112 30340	Super Soft ties 30cm (C720)
112 30350	Super soft ties 40cm (C721)
112 30360	Super soft ties 50cm (C722)
112 30370	Super soft ties 60cm (C723)

Chainlock Ties

For all general tying needs. Twist to lock. Economical, stretches with plant growth.



CODE	DESCRIPTION
112 30790	No 2 standard gauge 25m (C215)
112 30800	No 3 standard gauge 25m (C218)
112 30810	No 4 standard gauge 25m (C219)
112 30820	No 5 standard gauge 25m (C220)

Nail On Plastic Strapping



CODE	DESCRIPTION
112 30300	25m x 2.5cm (C258)
112 30310	25m x 3.8cm (C259)

Nail On Rubber Strapping



CODE	DESCRIPTION
112 30320	20m x 2.5cm (C291)
112 30330	20m x 3.8cm (C292)

Easy Fix Nail On Strapping

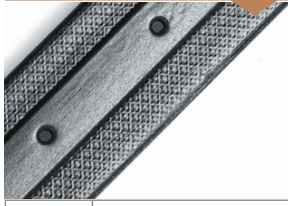

CODE	DESCRIPTION
112 36300	25m x 2.5cm (C254)
112 36310	25m x 3.8cm (C253)

Steel Reinforced Strapping



CODE	DESCRIPTION
112 30220	Steel Reinforced Strap 2.5cm x 20m (C198)

Biodegradable Nature Tie



Naturetie Hessian Strapping can be used similarly to other tie materials but has the advantage of decomposing over time.

CODE	DESCRIPTION
112 30325	Naturetie Biodegradeable Tree Strapping 50mm x 30m roll

Cable Ties



CODE	DESCRIPTION
112 35100	100mm x 2.5mm (Packs 100)
112 35110	300mm x 4.8mm (packs 100)

Spindlesh Tying



CODE	DESCRIPTION
112 30380	Spindlesh tying tool (C315)
112 30381	Spindlesh tube 3mm x 100m (C310)
112 30382	Spindlesh tube 5mm x 100m (C313)
112 30383	Cleats for tying tool (1000) (C305)

Hoop Collars



CODE	DESCRIPTION
113 30240	1.3cm (C229)
113 30250	2.5cm (C230)
113 30260	3.8cm (C231)

Rubber Tree Cushion



CODE	DESCRIPTION
113 30270	2.5cm (C295)
113 30280	3.8cm (C296)

Standard Rubber Tree Pad



CODE	DESCRIPTION
113 30700	Standard rubber tree pad 25mm

Extra Large Rubber Tree Pad



CODE	DESCRIPTION
113 30710	Extra large rubber tree pad

Dual Purpose Tree Pad



CODE	DESCRIPTION
113 30720	Dual purpose plastic tree pad

Flat-Back Rubber Tree Pad



CODE	DESCRIPTION
113 30730	Flat back rubber tree pad 25mm

Multi Stake Tree Support



For use where two or three stakes are employed to support trees. This system provides far greater stability than just strapping on its own, and gives a neat finish.

CODE	DESCRIPTION
113 34230	0.3m x 25mm Plastic sleeve
113 34220	1m x 37.5mm Rubber sleeve

Root Irrigation Systems



The cost effective watering system for trees and specimen shrubs. The root irrigation system is placed in position when the tree is planted, reducing drought losses and watering time, encouraging deeper root growth and enabling the trees to be fed with soluble feeds during the growing season.

CODE	DESCRIPTION
114 37200	Pipe dia 35mm x 1.25m
114 37210	Pipe dia 35mm x 1.75m
114 37220	Pipe dia 35mm x 2.5m
114 37230	Pipe dia 35mm x 4.0m

Irrigation Pipe



CODE	DESCRIPTION
114 37240	60mm x 50m Perforated Irrigation Pipe (Black)
114 37241	60mm x 150m Perforated Irrigation Pipe (Black)

Plastic Caps



CODE	DESCRIPTION
114 37245	Red plastic caps to fit 60mm Irrigation Pipe

Root Director

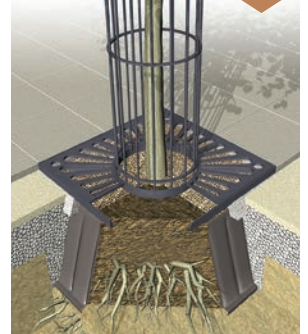

One piece root control planters. Designed to be installed at the time of planting, the Root Director has tapered sides and integral vertical ribs to divert root growth down and away from pavements and out for anchorage. Root directors are available in two sizes and have optional watering vents to convey water rapidly to the root zone.

CODE	DESCRIPTION
118 36051	Root Director 460mm x 640mm
118 36052	Root Director 550mm x 1050mm

Root Barrier



Designed to keep tree roots away from services and from damaging pavements and curbs, the heavy duty root barrier is double sided meaning it can be used between two trees or shrubs to prevent roots from growing together.

CODE	DESCRIPTION
318 36055	RootBarrier650 - 650mm (h) £/m
318 36056	Heavy Duty RootBarrier1000 - 1000mm (h) £/m

Gripple Root Fast



Gripple Root Fast - this method of securing trees has many advantages over staking and is suitable for larger root balled trees. Either by driving stakes into the ground close to the rootball then fastening wires between them or by using heavy timbers in the base of the pit to secure the wires to. The technique is easy to apply, inexpensive and invisible.

Available in 2m, 3m and 5m lengths. (1 pair per tree required).

CODE	DESCRIPTION
115 1610	Gripple hang fast 2m (Need 2 per tree)
115 1611	Gripple hang fast 3m (Need 2 per tree)
115 1612	Gripple hang fast 5m (Need 2 per tree)

Guying Wire



CODE	DESCRIPTION
115 16120	Guying Wire 3mm x 100m

Gripple



CODE	DESCRIPTION
227 16690	Medium Gripplers
227 16670	Gripple Tensioning Tool

Anchor Driving Rods

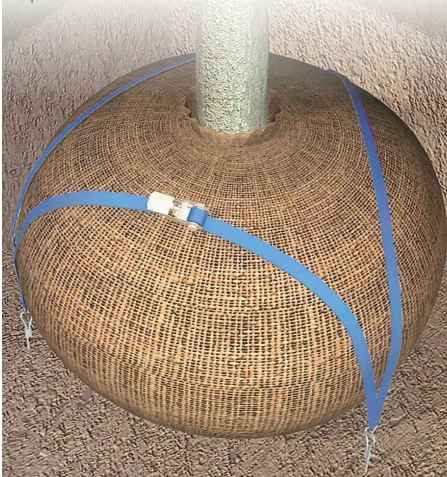

Image shows how ground anchor driven in before driving rod is extracted

CODE	DESCRIPTION
115 16131	Earth anchor driving rod - M
115 16133	Earth anchor driving rod - L

Ratchet Anchoring System

Anchor Kit Ratchet System. Uses a ratchet strap to secure the rootball. This system had the advantages of not needing any timber or making to prevent the rootball being cut, and can be retensioned at a later date if required.



CODE	DESCRIPTION
115 16140	Anchor Kit Ratchet System - M. Uses a ratchet strap to secure rootball. Suitable for trees up to 25cm girth.
115 16142	Anchor Kit Ratchet System - L. Uses a ratchet strap to secure rootball. Suitable for trees up to 40cm girth.

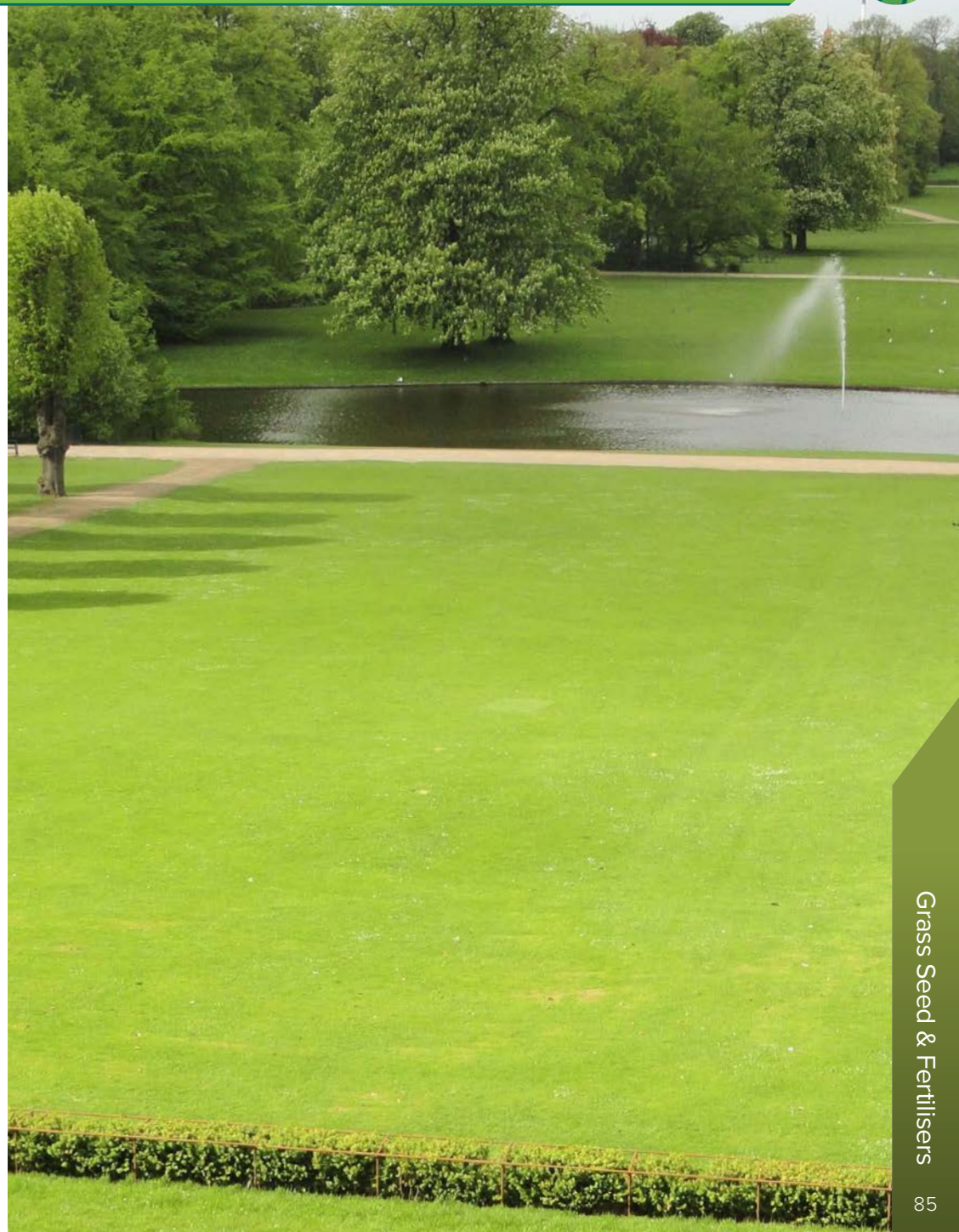

High Quality Fine Lawns



CODE	DESCRIPTION
101 02160	Pro Master 20 Fineturf - High Quality Fine Lawns (20kg)
101 02161	Luxury Lawn Grass Seed (1.5kg)

Shaded Conditions



CODE	DESCRIPTION
101 02162	Pro Master 60 Greenshade - Shaded Conditions (20kg)
101 02163	Shady Place Grass Seed (1.5kg)

High Quality Hard Wearing



CODE	DESCRIPTION
101 02164	Pro Master 50 Quality Lawn (20kg)
101 02165	Quick Lawn Grass Seed - with GrowMax (1.5kg)

Sports Field Renovation



CODE	DESCRIPTION
101 02166	Pro Master 79 - Hard Wearing Playing Field Grass (20kg)
101 02168	Pro Master 81 Premier Pitch Sports Field Renovation (20kg)

Dry & Impoverished Areas & DOT Mix



CODE	DESCRIPTION
101 02172	Pro Master 85 DOT Mix (20kg)
101 02170	Pro Master 25 Gro-Slow (20kg)

Agricultural Leys



CODE	DESCRIPTION
101 02174	Pro Pony Paddock Grazing Mix

Fertilisers



CODE	DESCRIPTION
102 02000	Growmore Fertiliser (a general fertiliser suitable for all crops as a base or top dressing)
102 02001	Lawn, Weed & Feed Fertiliser (controls many broad leaved weeds & nourishes grass)
102 02002	Lawn, Weed, Feed & Moss Killer (triple action lawn fertiliser, weeds, nourishes grass & kills moss)
102 02003	Fish, Blood & Bone (balanced, organically based fertiliser)
102 02004	Lawn Fertiliser (spring & summer)
102 02005	Lawn Fertiliser (autumn & winter)

Compost



CODE	DESCRIPTION
102 11630	Tree & Shrub Planting Compost (60ltr bag)



Mulches



CODE	DESCRIPTION
111 90710	Medium Amenity Mulch (0.8m3 bulk bag)
111 90720	Playground/Ornamental bark mulch (0.8m3 bulk bag)

i For information on how to calculate how much mulch you require, please turn to page 4.

Mulch Matting



CODE	DESCRIPTION
109 31040	0.5m x 0.5m pre cut mats
109 31050	1.0m x 1.0m pre cut mats
109 31030	1m x 50m roll
109 30030	2m x 50m roll
109 31031	1m x 100m roll
109 31032	2m x 100m roll

Pre-Cut Biodegradable Weed Mat



CODE	DESCRIPTION
109 31029	1m x 1m x 450gsm

Weed Mat Pegs

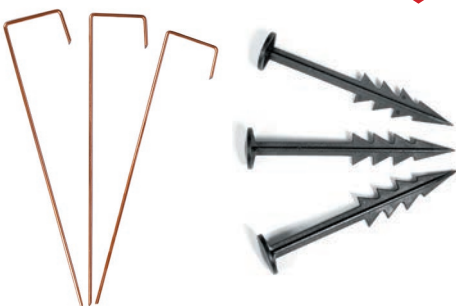

CODE	DESCRIPTION
109 35130	Plastic
109 35140	Metal

Windbreak

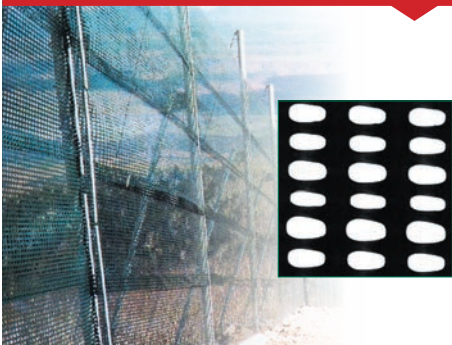

CODE	DESCRIPTION
110 30120	1m (h) x 50m roll (15mm x 40mm mesh size)



Spades	90
Shovels	90-91
Forks	91-92
Rakes	92
Cultivating & Cutting	93
Saws	93-94
Loppers & Shears	95
Secateurs	95-96
Wood Splitting	96
Fiskars Range	97-98
Brushes	98
Fencing Tools	98-100
Measuring	100
Levelling & Marking	101
Hammers	101
Torches	101
Buckets & Barrows	102
Drill Bits	102
Nail & Staple Guns	103
Load Securing	103
Knives	103
Pest Control	104-105
Containers	106
Sprayers & Accessories	106-107
Hose & Fittings	107-110

Digging Spade



CODE	DESCRIPTION
302 23020	Digging spade - Plastic 'YD' Handle

Hedging Spade



CODE	DESCRIPTION
302 23043	Hedging spade - Metal 'YD' Handle

Open Socket Shovel



CODE	DESCRIPTION
304 24010	Open Socket Shovel - No. 2

Border Spade



CODE	DESCRIPTION
302 23000	Border spade - Plastic 'YD' Handle

Newcastle Drainer Spade



CODE	DESCRIPTION
302 24340	Newcastle Drainer - Metal 'YD' Handle

Square Mouth Shovel



CODE	DESCRIPTION
304 23059	Square Mouth Contractors Shovel

Flat Treaded Garden Spade



CODE	DESCRIPTION
302 23042	Flat Treaded Garden Spade - Plastic 'YD' Handle

Rabbiting Spade



CODE	DESCRIPTION
302 00096	Rabbiting Spade - Wooden 'T' handle

Cable Laying Shovel



CODE	DESCRIPTION
304 24330	Cable laying shovel - All Metal

Trenching Shovel



CODE	DESCRIPTION
304 24240	Trenching Shovel - All Metal

Insulated Shovel - Square



CODE	DESCRIPTION
304 23056	Insulated Shovel - Square Mouth

Garden Fork



CODE	DESCRIPTION
303 23130	Garden Fork - Plastic 'YD' Handle

Round Mouth Shovel



CODE	DESCRIPTION
304 23054	Round Mouth Shovel - General Service

Insulated Shovel - Taper



CODE	DESCRIPTION
304 23057	Insulated Shovel - Taper Mouth

Border Fork



CODE	DESCRIPTION
303 23110	Border Fork - Plastic 'YD' Handle

Aluminium Grain Shovel



CODE	DESCRIPTION
304 24140	Aluminium Grain Shovel

Insulated Shovel - Treaded



CODE	DESCRIPTION
302 23058	Insulated General Service Shovel - Treaded

Premier Digging Fork

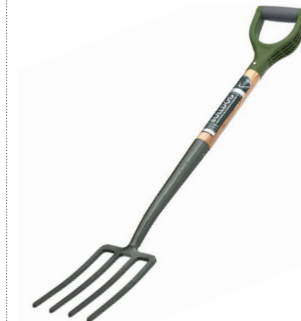

CODE	DESCRIPTION
303 23120	BULLDOG- Premier Digging Fork

Tarmac Fork



CODE	DESCRIPTION
303 23210	Tarmac Fork

Trenching Fork



CODE	DESCRIPTION
303 23170	Trenching Fork MYD - All Metal

Insulated Trenching Fork



CODE	DESCRIPTION
303 23088	Insulated Trench Fork

Manure Fork



CODE	DESCRIPTION
303 23230	Manure Fork 4 prong - MYD

Springbok Lawn Rake



CODE	DESCRIPTION
305 32520	Premier springbok lawn rake

Tubular Handled Lawn Rake



CODE	DESCRIPTION
305 32560	Plastic Lawn Rake - tubular handle

Wooden Handled Lawn Rake



CODE	DESCRIPTION
305 32561	Plastic Lawn Rake - wooden handle

Aluminium Landscape Rake



CODE	DESCRIPTION
305 23061	Aluminium Rake - 72" Handle

Tarmac Rake - Ash Handle



CODE	DESCRIPTION
305 32541	Tarmac Rake - 48" Handle

Leaf & Grass Rake



CODE	DESCRIPTION
305 32570	Chelwood poly leaf & grass rake 25" (32P)

Landscape Rake



CODE	DESCRIPTION
305 32580	Chelwood landscape rake (18E)

Hay Rake



CODE	DESCRIPTION
305 32600	Chelwood Polyprop Hay Rake (16P)

Trowel & Weed Fork



CODE	DESCRIPTION
306 23045	Evergreen Hand Trowel
306 23046	Evergreen Weed Fork

Dutch Hoe



CODE	DESCRIPTION
306 23410	Dutch Hoe

Little Giant Grass Hook



CODE	DESCRIPTION
308 17500	Little Giant Grass Hook

Newton Bill Hook



CODE	DESCRIPTION
308 17780	Newton Bill Hook

Brushing Hook



CODE	DESCRIPTION
308 25000	Brushing Hook

Edging Knife



CODE	DESCRIPTION
308 25150	Edging Knife - T-handle

Sabretooth Hand Saws



CODE	DESCRIPTION
307 17061	Hand Saw 1st Fix
307 17071	Hand Saw 940 Fine Cut

Irwin Jackcut Hand Saw



CODE	DESCRIPTION
307 17060	Irwin Jackcut saw

24" Bowsaw



CODE	DESCRIPTION
307 17080	24" W/W Bowsaw
307 25410	Swedish steel blade 24"

21" Bowsaw (Peardrop)



CODE	DESCRIPTION
307 17090	21" W/W Bowsaw (peardrop)
307 25400	Swedish steel blade 21"

Folding Silky Saw



CODE	DESCRIPTION
307 60071	Silky Saw F180-8 Folding Blade
307 60077	Silky F180-8 spare blade

Heavy Duty Silky Hand Saw



CODE	DESCRIPTION
307 60072	Silky Saw Zubat 270-7.5 c/w sheath
307 60076	Silky Zubat 270 spare blade
307 60075	Silky Zubat 3300 Telescopic Pole Saw (17' reach)

Holesaw Cutter



CODE	DESCRIPTION
314 61034	Holesaw Cutter - 35mm
314 61033	Holesaw Cutter - 38mm
314 61032	Holesaw Cutter - 60mm

Folding Silky Pocket Saw



CODE	DESCRIPTION
307 60073	Silky Pocketboy 170-10 Folding Saw
307 60081	Silky Pocketboy spare blade 170-10

Pruning Silky Saw



CODE	DESCRIPTION
307 60078	Silky Saw Gomtaro 300-8 c/w sheath
307 60079	Silky Gomtaro 300 spare blade

Holesaw Arbor



CODE	DESCRIPTION
314 61031	Holesaw Arbor - 32-210mm

Hacksaws



CODE	DESCRIPTION
307 25390	12" hacksaw blade
307 17730	12" Hacksaw

Super Accel Silky Saw



CODE	DESCRIPTION
307 60074	Silky Saw Super Accel 210-7.5 Folding Blade

By-pass Lopper - 27"



CODE	DESCRIPTION
308 17600	27" by-pass lopper

By-pass Lopper - Telescopic



CODE	DESCRIPTION
308 17450	Telescopic Bypass Lopper

Anvil Lopper



CODE	DESCRIPTION
308 17590	Anvil Lopper

Lawn Shears



CODE	DESCRIPTION
308 17960	Lawn shears

Hedge Shears



CODE	DESCRIPTION
308 17630	Hedge shears

Lawn Edging Shears



CODE	DESCRIPTION
308 17950	Evergreen Edging shears

Tree Pruner



CODE	DESCRIPTION
308 17550	Tree Pruner & saw
308 32740	Telescopic Pole (upto 2.4m)

Budget Secateurs



CODE	DESCRIPTION
308 17720	Budget Secateurs

Bypass Pruning Secateurs



CODE	DESCRIPTION
306 23050	Bypass Pruning - Small Grip
306 23049	Bypass Pruning - Std Grip

Anvil Pruning Secateurs



CODE	DESCRIPTION
306 23051	Anvil Pruning - Small Grip
306 23052	Anvil Pruning - Std Grip

Felco Essential Secateurs



CODE	DESCRIPTION
308 60180	Felco 160L Essential Secateurs

Felco Original Secateurs



CODE	DESCRIPTION
308 60110	Felco original secateurs (Model 2) L109

Felco Ergonomic Secateurs



CODE	DESCRIPTION
308 60150	Felco ergonomic secateur (Model 7) L91

Felco Standard Secateurs



CODE	DESCRIPTION
308 60120	Felco standard secateurs (Model 4) L125

Felco Ergonomic Secateurs



CODE	DESCRIPTION
308 60160	Felco ergonomics secateur (Model 8) L117

Felco Economy Secateurs



CODE	DESCRIPTION
308 60130	Felco economy secateurs (Model 5) L83

Felco Grower Secateurs



CODE	DESCRIPTION
319 60170	Felco grower secateurs (Model 11) FM11

Felco Ergonomic Secateurs



CODE	DESCRIPTION
308 60140	Felco ergonomics secateur (Model 6) L75

Felco Accessories



CODE	DESCRIPTION
308 60010	Felco cutting blade
308 60011	Felco lower blade
307 60060	Felco leather holster 910

Hand Axe - Tubular



CODE	DESCRIPTION
309 19150	Hand axe - Tubular handle

Hand Axe - Hickory



CODE	DESCRIPTION
318 19140	Hand axe - Hickory handle (1 1/2 lb)

Axes - Fibreglass Handle



CODE	DESCRIPTION
309 19240	Felling Axe - 4lb
309 19261	Splitting Maul - 6lb

Carpenters Axe - X10



CODE	DESCRIPTION
309 00500	Fiskars Carpenters Axe - X10

Chopping Axe - X15



CODE	DESCRIPTION
309 00501	Fiskars Chopping Axe - X15

Splitting Axes



CODE	DESCRIPTION
309 00502	Fiskars Splitting Axe - X17
309 00503	Fiskars Splitting Axe - X25
307 00506	Fiskars Splitting Axe - X27

Axe & Knife Sharpener



CODE	DESCRIPTION
309 00504	Fiskars Xsharpe Axe & Knife Sharpener

Hedge Shears - Wavy Blade



CODE	DESCRIPTION
308 00507	Fiskars SingleStep Hedge Shear - Wavy Blade (HS22)

Hedge Shears - Telescopic



CODE	DESCRIPTION
308 00508	Fiskars SmartFit Hedge Shear - Telescopic (HS86)

Hedge Shears - PowerGear



CODE	DESCRIPTION
308 00509	Fiskars Hedge Shear - PowerGear (HS72)

Maintenance Kit



CODE	DESCRIPTION
308 00514	Fiskars Maintenance Kit

Pruning Saw



CODE	DESCRIPTION
307 00505	Fiskars Xtract Pruning Saw - 160mm

Loppers - SingleStep



CODE	DESCRIPTION
308 00510	Fiskars Bypass Lopper - SingleStep (S L28)

Loppers - Telescopic



CODE	DESCRIPTION
308 00511	Fiskars SmartFit Telescopic Lopper (L86)

Loppers - PowerGear



CODE	DESCRIPTION
308 00512	Fiskars Bypass Lopper - PowerGear (M) L74
308 00513	Fiskars Bypass Lopper - PowerGear (L) L78

Brush Hook - WoodXpert



CODE	DESCRIPTION
308 00515	Fiskars WoodXpert Brush Hook (XA3)

Secateurs - Bypass



CODE	DESCRIPTION
308 00517	Fiskars SingleStep Pruner - Bypass (P26)

Secateurs - Anvil



CODE	DESCRIPTION
308 00518	Fiskars SingleStep Pruner - Anvil (P25)

Secateurs - SmartFit



CODE	DESCRIPTION
308 00519	Fiskars SmartFit Pruner - Bypass (P68)

Secateurs - PowerGear



CODE	DESCRIPTION
308 00520	Fiskars PowerGear Pruner - Bypass (S/M P92)
308 00521	Fiskars PowerGear Pruner - Bypass (L P94)

Garden Scissors



CODE	DESCRIPTION
308 00516	Fiskars Universal Garden Scissors 18cm (S92)

Red PVC Brush



CODE	DESCRIPTION
310 32716	Red PVC Yard Broom - 12"
310 32720	Red PVC Platform Broom - 18"
310 32730	Red PVC Platform Broom - 24"

Black Platform Broom



CODE	DESCRIPTION
310 33150	Flagged black coco platform broom 18" (H6/3)
310 34000	Flagged black coco platform broom 24" (H6/5)

Bahia Mix Platform Broom



CODE	DESCRIPTION
310 32700	Bahia mix platform broom 18"
310 32710	Bahia mix platform broom 24"

Paint Brushes



CODE	DESCRIPTION
310 38151	Paint Brush 1/2"
310 38150	Paint Brush 1"
310 38140	Paint Brush 1 1/2"
310 38130	Paint Brush 2"
310 38120	Paint Brush 3"
310 38110	Paint Brush 4"
318 38161	Fence Paint Brush

Fencing Bar



CODE	DESCRIPTION
311 20351	Fencing Bar

BT Pattern Post Hole Digger



CODE	DESCRIPTION
302 25310	BT pattern post hole digger spade (72" handle)

Excavator Fencers Graft

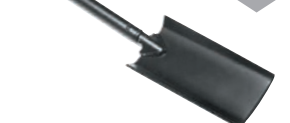

CODE	DESCRIPTION
311 25320	Excavator Fencers Graft 4'6" - black steel handle

Carters Fencing Graft



CODE	DESCRIPTION
311 25321	Carters Fencers graft 4'6" - steel handle

Bulldog Grafting Tool



CODE	DESCRIPTION
302 24370	Grafting Tool - All Metal

Post Hole Digger



CODE	DESCRIPTION
311 23441	Light Duty - Wooden Handle
311 23460	Light Duty - Fibreglass Handle
311 23440	Heavy Duty - Wooden Handle
311 23461	Heavy Duty - Fibreglass Handle

Earth Rammer



CODE	DESCRIPTION
313 25070	Wooden Handle
311 25080	Steel Handle

Crowbar - Chisel & Point



CODE	DESCRIPTION
312 20350	Crowbar - Chisel & Point - 60" x 1 1/8"

Gooseneck Wrecking Bar



CODE	DESCRIPTION
312 16080	Gooseneck wrecking bar 18"
312 16090	Gooseneck wrecking bar 24"
312 16100	Gooseneck wrecking bar 30"

Carpenters Adze



CODE	DESCRIPTION
311 18011	Carpenters Adze - 36" Hickory Handle

Post Driver



CODE	DESCRIPTION
311 31020	Post driver 6"

Monkey Wire Strainer



CODE	DESCRIPTION
311 18360	Monkey Wire Strainer

Standard Wire Strainer



CODE	DESCRIPTION
311 18370	Chain Strainer (no spring)

Boundary Wire Strainer



CODE	DESCRIPTION
311 23480	Boundary Strainer c/w 6 metres of chain (Hook)

Easy Fencer Wire Strainer



CODE	DESCRIPTION
311 18390	Easy Fencer Wire Strainer

Drivall Boundary Clamp



CODE	DESCRIPTION
311 27100	Drivall boundary clamp 110 cm long
311 27110	Drivall boundary deer clamp 220 cm long

Wire Reel Dispenser

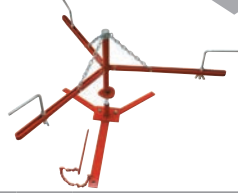

CODE	DESCRIPTION
311 19070	Wire reel dispenser spinning jenny (spike)

Ezepull Pliers



CODE	DESCRIPTION
311 18400	Ezepull pliers

Fencing Pliers



CODE	DESCRIPTION
311 18410	Fencing pliers

Wire Cutting Pliers



CODE	DESCRIPTION
311 18430	Wire cutting pliers

Wire Cutters



CODE	DESCRIPTION
311 18420	8" Wire Cutters

Bolt Cutters



CODE	DESCRIPTION
311 18421	14" Bolt cutters

Felco Wire Cutters



CODE	DESCRIPTION
311 60100	Felco wire cutters C7

Felco Multi Use Wire Cutters



CODE	DESCRIPTION
311 60090	Felco multi-purpose wire cutters CP

Wire Twisters



CODE	DESCRIPTION
311 18031	Wire Twisters

Retractable Tape Measure



CODE	DESCRIPTION
312 18240	ATF Tape Measure 5m
312 18250	ATF Tape Measure 8m

Surveyors Tape Measure



CODE	DESCRIPTION
312 18220	Surveyors Tape Measure 30m
312 18230	Surveyors Tape Measure 50m
312 18231	Surveyors Tape Measure 100m

Measuring Wheel



CODE	DESCRIPTION
312 20340	Digital Counter Measuring Wheel

Spirit Levels



CODE	DESCRIPTION
312 18260	Spirit Level 600mm
312 18261	Spirit Level 1000mm
312 00103	Spirit Level 1200mm

Post Level



CODE	DESCRIPTION
312 18262	Post Level - Hi-vis

String



CODE	DESCRIPTION
323 36062	18m Orange String Line
317 00227	Ball of String

Aerosol Spray Marker Paint



CODE	DESCRIPTION
323 00008	Aerosol Red Spray
323 00180	Aerosol Blue Spray
323 00181	Aerosol Green Spray
323 00182	Aerosol Yellow Spray
323 00201	Aerosol White Spray

Claw Hammers



CODE	DESCRIPTION
313 18550	Hickory Handle - 16oz
313 18540	Hickory Handle - 20oz
313 18560	Tubular Handle - 16oz
313 18570	Tubular Handle - 20oz
313 00193	Anti-vibe Handle - 20oz

Lump Hammer - Fiberglass



CODE	DESCRIPTION
313 18640	Fiberglass Handle - 2 1/2lbs
313 18650	Fiberglass Handle - 4lbs

Sledge Hammer - Hickory



CODE	DESCRIPTION
313 25230	Sledge Hammer - 7lb
313 25220	Sledge Hammer - 10lb
313 25210	Sledge Hammer - 14lb

Fence Maul - Fiberglass



CODE	DESCRIPTION
313 25110	Fence Maul - 12lb
313 25120	Fence Maul - 14lb

Pocket Torch



CODE	DESCRIPTION
301 18765	Pocket Torch - Elite Focus with three functions

Rechargeable Hand Torch



CODE	DESCRIPTION
301 18760	Rechargeable Hand Torch - Elite Nova Sportlight with Li-ion batteries

Heavy Duty Hand Torch



CODE	DESCRIPTION
301 18770	Heavy Duty Hand Torch - Krypton Bulb complete with 6v Battery

Buckets



CODE	DESCRIPTION
323 39040	Heavy Duty Bucket-3 Gallons (yellow)

Wheelbarrows



CODE	DESCRIPTION
316 30001	Haemmerlin Contractors Wheelbarrow

Spreaders



CODE	DESCRIPTION
327 39510	Walk Behind Fertiliser Spreader - plastic hopper (60lbs)
327 39500	Walk Behind Fertiliser Spreader - plastic hopper (80lbs)

Drill Bits - Masonry



CODE	DESCRIPTION
314 60998	5.5mm x 150mm
314 60995	6mm x 150mm
314 60999	7mm x 150mm
316 61000	8mm x 150mm
314 61003	8mm x 300mm
314 61001	10mm x 150mm
314 61004	10mm x 300mm
314 61002	12mm x 150mm
314 61005	12mm x 300mm
314 60997	14mm x 150mm
314 61006	14mm x 300mm
314 60996	16mm x 150mm

Drill Bits - Auger (Wood)



CODE	DESCRIPTION
314 61021	8mm x 200mm
314 61022	8mm x 400mm
314 61010	10mm x 200mm
314 61013	10mm x 400mm
314 61023	13mm x 200mm
314 61024	13mm x 400mm
314 00190	19mm x 200mm
314 61025	19mm x 400mm
314 61026	22mm x 200mm
314 61027	22mm x 400mm

Drill Bits - Spade (Wood)



CODE	DESCRIPTION
314 61007	25mm x 152mm
314 61008	28mm x 152mm
314 61009	30mm x 152mm
314 61017	32mm x 152mm

i See page 94 for our holesaw range

Drill Bits - HSS (Metal)



CODE	DESCRIPTION
314 61060	1.00mm (Pack 3)
314 61061	3.00mm (Pack 2)
314 61062	4.00mm (Pack 2)
314 61063	5.00mm (Pack 2)
314 61064	6.00mm (Pack 2)
314 61065	7.00mm (Pack 1)
314 61066	8.00mm (Pack 1)
314 61067	9.00mm (Pack 1)
314 61068	10.00mm (Pack 1)
314 61069	11.00mm (Pack 1)
314 61070	12.00mm (Pack 1)
314 61071	13.00mm (Pack 1)

Drill Bits - 13 Piece Set



CODE	DESCRIPTION
319 61040	Avit Drill Bit Set - 13 Pieces

Screwdriver Bits - Pozi



CODE	DESCRIPTION
314 60362	PZ2 25mm - Pack of 10

Screwdriver Bits Set



CODE	DESCRIPTION
314 60361	Metabo Bit Set - 15 Piece

Staple Gun



CODE	DESCRIPTION
315 35150	Heavy Duty Staple Gun
315 35163	Staples 6mm - box of 1000
315 35162	Staples 8mm - box of 1000
315 35161	Staples 10mm - box of 1000
315 35160	Staples 12mm - box of 1000

Cordless Gas Staple Gun



CODE	DESCRIPTION
311 14105	GT40FS Cordless Staple Gun

i See page 78 for staples for cordless staple gun

Cordless Gas Nail Gun



CODE	DESCRIPTION
233 14110	GT90CH Cordless Nail Gun

i See page 77 for nails for cordless nail gun

Ratchet Straps



CODE	DESCRIPTION
317 17830	4m x 25mm (0.7 tonne)
317 17840	6m x 25mm (0.7 tonne)
317 17850	6m x 50mm (5 tonne)
317 17860	8m x 50mm (5 tonne)

Blue Poly Rope



CODE	DESCRIPTION
317 36061	6mm x 30m
317 36000	6mm x 220m
317 36060	10mm x 27m (Wagon Eye)
317 36020	10mm x 220m

Tarpaulin



CODE	DESCRIPTION
317 18710	5.4m x 3.5m (18' x 12')
317 18720	7.0m x 5.4m (23' x 18')
317 18740	9.0m x 7.0m (30' x 23')

Duct Sealing Tape



CODE	DESCRIPTION
312 17520	50mm x 50m
312 17530	75mm x 50m

Pen Knife - Budget



CODE	DESCRIPTION
314 61030	Budget Knife - 70mm Blade

Pen Knives - Opinel



CODE	DESCRIPTION
319 64000	Opinel No 3
319 64001	Opinel No 5
319 64002	Opinel No 6
319 61050	Opinel No 6 Blister pack
319 64003	Opinel No 7
319 61051	Opinel No 7 Blister pack
319 64004	Opinel No 8
319 61052	Opinel No 8 Blister pack
319 64005	Opinel No 9
319 64006	Opinel No 10

Pen Knives - Novelty



CODE	DESCRIPTION
319 00241	Bullet Knife
319 00240	Cartridge Knife

Stanley Knife



CODE	DESCRIPTION
312 00126	Stanley Knife - Retractable Blade
312 00011	Stanley Knife Spare Blades (pk 5)

Machete



CODE	DESCRIPTION
308 00084	Machete - carbon steel blade

Knife & Scissor Sharpener



CODE	DESCRIPTION
308 00184	Knife and scissor sharpening tool

Deterrence - Ultrasonic



CODE	DESCRIPTION
324 00170	Ultrasonic Indoor Pest Repeller (for whole house)
324 00169	Outdoor Pest Repeller (for rodents, cats, dogs & foxes)

Deterrence - Mole Repeller



CODE	DESCRIPTION
324 00171	Electronic Mole Reppeller

Deterrence - Fence Spikes



CODE	DESCRIPTION
324 00220	Prikka Strip - 45mm x 500mm strips (Pk of 8)

Deterrence - Bird Spikes



CODE	DESCRIPTION
324 00225	Professional Bird Spikes (10 x 500mm)

Mouse Bait Station



CODE	DESCRIPTION
324 00224	Prebaited Mouse Station
324 00223	Mouse Killer Refill Sachet

Rat Bait Station



CODE	DESCRIPTION
324 00219	Rat Bait Station

Rat Bait Tube

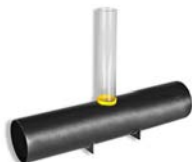

CODE	DESCRIPTION
324 00228	Rat Bait Tube

Rat Poison



Approved certification is required for rodenticide use

CODE	DESCRIPTION
324 00178	Wildcat Rat Poison - 10kg
324 32336	Wildcat Rat Poison CX - 60x100g Packs
324 00217	Neosorex Rat Poison - 3kg

Live Trap - Mice



CODE	DESCRIPTION
324 34340	Triptrap - Live Mouse Trap

Live Trap - Rats



CODE	DESCRIPTION
324 34210	Wire Rat Cage 14" (spring loaded back door)

Live Trap - Rabbits



CODE	DESCRIPTION
324 30060	Wire Rabbit Cage 32" (spring loaded back door)

Fly Papers



CODE	DESCRIPTION
324 00226	Fly Papers (4 Pk)

Mouse Trap - Little Nipper



CODE	DESCRIPTION
324 34360	Little Nipper Mouse Trap

Mouse Trap - Metal Self Set



CODE	DESCRIPTION
324 34380	Metal Self Set Mouse Trap

Mouse Trap - Pre-baited



CODE	DESCRIPTION
324 34420	Pre-baited Self Set Mouse Trap

Rat Trap - Little Nipper



CODE	DESCRIPTION
324 34350	Little Nipper Rat Trap

Rat Trap - Electronic



CODE	DESCRIPTION
324 34355	Electronic Rat Trap - Battery Operated

Mole Trap - Scissor Type



CODE	DESCRIPTION
324 34320	Scissor Mole Trap

Mole Trap - Tunnel Type



CODE	DESCRIPTION
324 34330	Tunnel mole trap

Fenn Traps



CODE	DESCRIPTION
324 34400	Mk4 - Rat Trap
324 34390	Mk6 - General Purpose Trap

Universal Seat Cover



CODE	DESCRIPTION
322 70001	Heavy Duty Seat Cover Universal Front-Black

Multifit Rear Seat Cover



CODE	DESCRIPTION
322 70011	Heavy Duty Seat Cover Multifit Rear-Black

Plastic Cans - 5ltr



CODE	DESCRIPTION
323 36080	Fuel Can Plastic Red 5 ltrs
323 36070	Fuel Can Plastic Green 5 ltrs
323 36090	Fuel Can Plastic Black 5 ltrs

Combi Fuel Can



CODE	DESCRIPTION
323 36150	3.5 Ltr Petrol / 1.5 Ltrs Oil

Jerry Cans



CODE	DESCRIPTION
323 36030	10Ltr Steel Jerry Fuel Can
323 36040	20Ltr Steel Jerry Fuel Can
323 36170	Jerry Fuel Can slip on spout

Plastic Water Container



CODE	DESCRIPTION
323 36095	25 Ltr Water Container

Measuring Jugs



CODE	DESCRIPTION
323 36440	Measuring jug 500ml
323 36430	Measuring jug 1 ltr
323 36420	Measuring jug 2 ltr
323 36410	Measuring Jug 3 ltr
323 36400	Measuring jug 5 ltr

Funnels



CODE	DESCRIPTION
309 36500	Poly funnel with flex spout
323 36490	Tractor Funnel 250x180mm

Plastic Pneumatic Sprayers



CODE	DESCRIPTION
325 25260	Mini Pro 1.5 ltr hand held sprayer
325 25250	Mini Pro 5 ltr professional sprayer
325 25240	Mini Pro 8 ltr professional sprayer

Knapsack Sprayer



CODE	DESCRIPTION
325 26000	Cooper Pegler CP15 Classic (15ltr diaphragm type)
325 26010	Cooper Pegler CP3 Classic (20ltr diaphragm type)
325 26020	Cooper Pegler CP15 Series 2000 (15ltr piston type)
325 26030	Cooper Pegler CP3 Series 2000 (20ltr piston type)

Plastic Lance

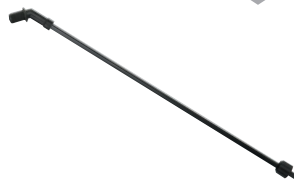

CODE	DESCRIPTION
325 80000	Plastic 500mm lance w/45 deg end (SA04415)

Plastic Extension Lance

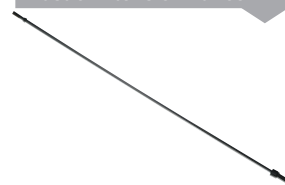

CODE	DESCRIPTION
325 80001	Plastic 1 mtr straight extension lance (SA04 434)

Plastic Spray Guard



CODE	DESCRIPTION
325 80010	15" spray guard c/w nozzle to fit plastic lance

Plastic Spray Tee Boom



CODE	DESCRIPTION
325 80003	Plastic 2 noz (0.5 mtr) spray T boom (SA04 431)
325 80004	Plastic 3 noz (1.0 mtr) spray T boom (SA04 420)
325 80005	Plastic 4 noz (1.5 mtr) spray T boom (SA04 432)

Plastic trigger Valve



CODE	DESCRIPTION
325 80002	Plastic trigger valve (SA15123)

Plastic Spray Nozzles



CODE	DESCRIPTION
325 80021	Polijet (yellow) cover 0.5 mtr wide @ 0.5 mtr H
325 80022	Polijet (green) cover 1.0 mtr wide @ 0.5 mtr H
325 80023	Polijet (blue) cover 1.5 mtr wide @ 0.5 mtr H
325 80024	Polijet (red) cover 2.0 mtr wide @ 0.5 mtr H
325 80020	Polijet nozzle pack (contains yellow, green, blue & red nozzles)

Nozzle Assembly



CODE	DESCRIPTION
325 80025	Nozzle assembly - takes all above nozzles

Garden Hose



CODE	DESCRIPTION
326 35280	Garden Hose 15m x 12.5mm dia green braided
326 35290	Garden Hose 30m x 12.5mm dia green braided
326 35300	Garden Hose 50m x 12.5mm dia green braided
326 31060	Garden Hose 75m x 12.5mm dia green braided

Commercial Hose



CODE	DESCRIPTION
326 35090	Trico Soleil Premier Hose 25m x 13mm dia yellow
326 35080	Trico Soleil Premier Hose 50m x 13mm dia yellow
326 35070	Trico Soleil Premier Hose 100m x 13mm dia yellow
326 35060	Trico Soleil Premier Hose 25m x 19mm dia yellow
326 35050	Trico Soleil Premier Hose 50m x 19mm dia yellow
326 35040	Trico Soleil Premier Hose 100m x 19mm dia yellow
326 35030	Trico Soleil Premier Hose 25m x 25mm dia yellow
326 35020	Trico Soleil Premier Hose 50m x 25mm dia yellow

Hose to Bayonet Connector



CODE	DESCRIPTION
326 65000	1/2" End Connector (Brass)
326 65001	3/4" End Connector (Brass)



Automatic Water Stop



CODE	DESCRIPTION
326 65080	1/2" Automatic Water Stop - End Connector (Brass)
326 65081	3/4" Automatic Water Stop - End Connector (Brass)

Hose To Hose Connector



CODE	DESCRIPTION
326 65010	1/2" Hose to Hose Connector (Brass)
326 65011	3/4" Hose to Hose connector (Brass)

Two Way Hose Connector



CODE	DESCRIPTION
326 65030	Two Way Hose Connector (Brass)

Threaded Tap Connector



CODE	DESCRIPTION
326 65050	1/2" Tap Connector (Brass)
326 65051	3/4" Tap Connector (Brass)

Male Thread Adaptor



CODE	DESCRIPTION
326 65060	1/2" Male Thread Adaptor (Brass)
326 65061	3/4" Male Thread Adaptor (Brass)

i See page 27 for outdoor brass bib taps

Hose to Bayonet Connector



CODE	DESCRIPTION
326 65200	1/2" End Connector (PVC)
326 65201	3/4" End Connector (PVC)

Hose To Hose Connector



CODE	DESCRIPTION
326 65210	1/2" Hose to Hose Connector (PVC)
326 65211	3/4" Hose to Hose Connector (PVC)

Two Way Hose Connector



CODE	DESCRIPTION
326 65240	Two Way Hose Connector (PVC)

Three Way Hose Connector



CODE	DESCRIPTION
326 65250	3 Way Hose Connector - Y Shaped (PVC)

Threaded Tap Connector



CODE	DESCRIPTION
326 65221	3/4" Tap Connector (PVC)

Male Thread Adaptor



CODE	DESCRIPTION
326 65220	1/2" Male Thread Adaptor (PVC)
326 65231	3/4" Male Thread Adaptor (PVC)

Quick Coupling - Hose Tail



CODE	DESCRIPTION
326 65100	1/2" Hose Tail - Quick Coupling (Brass)
326 65101	3/4" Hose Tail - Quick Coupling (Brass)
326 65102	1" Hose Tail - Quick Coupling (Brass)

Quick Coupling - Female



CODE	DESCRIPTION
326 65110	1/2" BSP Female - Quick Coupling (Brass)
326 65111	3/4" BSP Female - Quick Coupling (Brass)
326 65112	1" BSP Female - Quick Coupling (Brass)
326 65113	7/8" BSP Female - Quick Coupling (Brass)

Quick Coupling - Male



CODE	DESCRIPTION
326 65120	1/2" BSP Male - Quick Coupling (Brass)
326 65121	3/4" BSP Male - Quick Coupling (Brass)
326 65122	1" BSP Male - Quick Coupling (Brass)

Quick Coupling - Connector



CODE	DESCRIPTION
326 65130	3 Way Y Shaped Connector - Quick Coupling (Brass)

Quick Coupling - Blind Caps



CODE	DESCRIPTION
326 65140	Blind Caps - Quick Coupling (Brass)

Quick Coupling - Water Stop



CODE	DESCRIPTION
326 65150	Automatic Water Stop - Quick Coupling (Brass)

Quick Coupling - "O" Ring



CODE	DESCRIPTION
326 65115	Spare "O" Ring - Quick Coupling (Rubber)

Sprinkler - Freestanding



CODE	DESCRIPTION
326 15411	Sprinkler freestanding stand pipe 1/2" (to be used with 15401, 15402 or 15403)

Sprinkler - Sled Base



CODE	DESCRIPTION
326 15408	Metal Sled Base (to be used with 15401, 15402 or 15403)

Sprinkler - Spike Base



CODE	DESCRIPTION
326 15404	Sprinkler spike base (to be used with 15401, 15402 or 15403)

Part Circle Plastic Sprinkler



CODE	DESCRIPTION
326 15402	Part circle plastic sprinkler (60-04-27-28)



Part Circle Metal Sprinkler



CODE	DESCRIPTION
326 15403	Part circle metal sprinkler (60-04-23-40)

Spray Gun



CODE	DESCRIPTION
326 15407	Pistol grip spray gun

Barbed Elbow



CODE	DESCRIPTION
326 65310	Porous pipe fittings 16mm barbed elbow

Rotary Sprinkler



CODE	DESCRIPTION
326 15401	Rotoframe unique low pressure sprinkler (59-00-10)

Hose Reel



CODE	DESCRIPTION
326 15344	Hozelock Hose Reel - Holds 60m of hose

Barbed Tee (for Porous Pipe)



CODE	DESCRIPTION
326 65320	Porous pipe fittings 16mm - 16mm -16mm Tee

Lawn Sprinkler



CODE	DESCRIPTION
326 15405	Oscillating lawn sprinkler

Porous Pipe



CODE	DESCRIPTION
326 36340	Porous pipe 15 metre pack
326 36350	Porous pipe 30 metre pack
326 36330	Porous pipe 50 metre roll
326 36320	Porous pipe 100 metre roll

Barbed Plug



CODE	DESCRIPTION
326 65330	Porous pipe fittings 16mm barbed plug

Spray Lance



CODE	DESCRIPTION
326 15406	Geka Softrain lance c/w plastic valve & rose - 60cm long

Barbed Connector



CODE	DESCRIPTION
326 65300	Porous pipe fittings 16mm barbed connector

Jubilee Clips



CODE	DESCRIPTION
326 15335	Jubilee clips MOO 11-16mm Dia -1/2" - 5/8" dia
326 15336	Jubilee clips OO 13-20mm Dia -1/2" - 3/4" dia
326 15337	Jubilee clips OX 17-25mm Dia -3/4" - 1" dia
326 15338	Jubilee clips IX 27-40mm Dia -1 1/8" - 1 5/8" dia



Gloves	112
Boots	113-114
Waterproof Clothing	115
Hi-Vis Clothing	115
PPE	116

Grain Leather Gloves



CODE	DESCRIPTION
401 21080	Unlined Grain Leather Gloves - Medium
401 21081	Unlined Grain Leather Gloves - Large
401 21082	Unlined Grain Leather Gloves - X Large

Thinsulate Leather Gloves



CODE	DESCRIPTION
401 21087	Thinsulate Lined Grain Leather Gloves - Medium
401 21088	Thinsulate Lined Grain Leather Gloves - Large
401 21089	Thinsulate Lined Grain Leather Gloves - X Large

Performance Leather Gloves



CODE	DESCRIPTION
401 21083	Performance Leather Glove - Medium
401 21084	Performance Leather Gloves - Large
401 21085	Performance Leather Gloves - X Large

Chrome Rigger Gloves



CODE	DESCRIPTION
401 21070	Standard Chrome Rigger Gloves

Furniture Hide Rigger Gloves



CODE	DESCRIPTION
401 21040	Furniture Hide Rigger Gloves

PVC Open End Gloves



CODE	DESCRIPTION
401 21090	Gloves PVC Open End

PVC Knit Wrist Gloves



CODE	DESCRIPTION
401 21050	Gloves PVC Knit Wrist Gloves

Nitrile Gloves



CODE	DESCRIPTION
401 00239	Nitrile Gloves

Latex Disposable Gloves



CODE	DESCRIPTION
401 00101	Latex Disposable Gloves (box 100)

Standard Spray Gloves



CODE	DESCRIPTION
401 21100	Standard Duty Spray Gloves

Heavy Duty Spray Gloves



CODE	DESCRIPTION
401 21020	Heavy Duty Spray Gloves

Handler Grip Gloves



CODE	DESCRIPTION
401 00202	Handler Grip Gloves

Thermal Grip Gloves



CODE	DESCRIPTION
401 02202	Thermal Grip Gloves

V12 Rocky Waterproof Hiker



CODE	DESCRIPTION
402 21310	Size 5 - Full Grain, Zip Sided
402 21311	Size 6 - Full Grain, Zip Sided
402 21312	Size 7 - Full Grain, Zip Sided
402 21313	Size 8 - Full Grain, Zip Sided
402 21314	Size 9 - Full Grain, Zip Sided
402 21315	Size 10 - Full Grain, Zip Sided
402 21316	Size 11 - Full Grain, Zip Sided
402 21317	Size 12 - Full Grain, Zip Sided
402 21318	Size 13 - Full Grain, Zip Sided

V12 Aztec Urban Hiker



CODE	DESCRIPTION
402 21272	Boots Size 6 V8431
402 21273	Boots Size 7 V8431
402 21274	Boots Size 8 V8431
402 21275	Boots Size 9 V8431
402 21276	Boots Size 10 V8431
402 21277	Boots Size 11 V8431
402 21278	Boots Size 12 V8431

V12 Rhino Boot - Black



CODE	DESCRIPTION
402 21283	Boots Size 6 V6863 Rhino
402 21284	Boots Size 7 V6863 Rhino
402 21285	Boots Size 8 V6863 Rhino
402 21286	Boots Size 9 V6863 Rhino
402 21287	Boots Size 10 V6863 Rhino
402 21288	Boots Size 11 V6863 Rhino
402 21289	Boots Size 12 V6863 Rhino
402 21290	Boots Size 13 V6863 Rhino

V12 Boulder Boot - Brown



CODE	DESCRIPTION
402 22853	Boots Size 6 V1236 Boulder
402 22854	Boots Size 7 V1236 Boulder
402 22855	Boots Size 8 V1236 Boulder
402 22856	Boots Size 9 V1236 Boulder
402 22857	Boots Size 10 V1236 Boulder
402 22858	Boots Size 11 V1236 Boulder
402 22859	Boots Size 12 V1236 Boulder
402 22860	Boots Size 13 V1236 Boulder

V12 Boulder Boot - Honey



CODE	DESCRIPTION
402 22803	Boots Size 6 V1237 Boulder
402 22804	Boots Size 7 V1237 Boulder
402 22805	Boots Size 8 V1237 Boulder
402 22806	Boots Size 9 V1237 Boulder
402 22807	Boots Size 10 V1237 Boulder
402 22808	Boots Size 11 V1237 Boulder
402 22809	Boots Size 12 V1237 Boulder
402 22810	Boots Size 13 V1237 Boulder

V12 Boulder Boot - Black



CODE	DESCRIPTION
402 22903	Boots Size 6 V1235 Boulder
402 22904	Boots Size 7 V1235 Boulder
402 22905	Boots Size 8 V1235 Boulder
402 22906	Boots Size 9 V1235 Boulder
402 22907	Boots Size 10 V1235 Boulder
402 22908	Boots Size 11 V1235 Boulder
402 22909	Boots Size 12 V1235 Boulder
402 22910	Boots Size 13 V1235 Boulder

V12 Rawhide



CODE	DESCRIPTION
402 21291	Boots Size 6 V1231 Rawhide
402 21292	Boots Size 7 V1231 Rawhide
402 21293	Boots Size 8 V1231 Rawhide
402 21294	Boots Size 9 V1231 Rawhide
402 21295	Boots Size 10 V1231 Rawhide
402 21296	Boots Size 11 V1231 Rawhide
402 21297	Boots Size 12 V1231 Rawhide
402 21298	Boots Size 13 V1231 Rawhide

Non Safety Dealer Boots



CODE	DESCRIPTION
402 21300	Size 6 Non-Safety Market Dealer Boots
402 21301	Size 7 Non-Safety Market Dealer Boots
402 21302	Size 8 Non-Safety Market Dealer Boots
402 21303	Size 9 Non-Safety Market Dealer Boots
402 21304	Size 10 Non-Safety Market Dealer Boots
402 21305	Size 11 Non-Safety Market Dealer Boots
402 21306	Size 12 Non-Safety Market Dealer Boots

Budget Wellington



CODE	DESCRIPTION
403 21000	Size 3 Budget Wellington
403 21001	Size 4 Budget Wellington
403 21002	Size 5 Budget Wellington
403 21003	Size 6 Budget Wellington
403 21004	Size 7 Budget Wellington
403 21005	Size 8 Budget Wellington
403 21006	Size 9 Budget Wellington
403 21007	Size 10 Budget Wellington
403 21008	Size 11 Budget Wellington
403 21009	Size 12 Budget Wellington

Toggi Keswick Wellington



CODE	DESCRIPTION
403 27020	Toggi Keswick - Size 5
403 27021	Toggi Keswick - Size 6
403 27022	Toggi Keswick - Size 7
403 27023	Toggi Keswick - Size 8
403 27024	Toggi Keswick - Size 9
403 27025	Toggi Keswick - Size 10
403 27026	Toggi Keswick - Size 10 1/2
403 27027	Toggi Keswick - Size 11

Safety Wellington



CODE	DESCRIPTION
403 21010	Size 6 Safety Wellington
403 21011	Size 7 Safety Wellington
403 21012	Size 8 Safety Wellington
403 21013	Size 9 Safety Wellington
403 21014	Size 10 Safety Wellington
403 21015	Size 11 Safety Wellington
403 21016	Size 12 Safety Wellington

Toggi Wanderer+ Wellington



CODE	DESCRIPTION
403 27030	Wanderer Plus - Size 5
403 27031	Wanderer Plus - Size 6
403 27032	Wanderer Plus - Size 7
403 27033	Wanderer Plus - Size 8
403 27034	Wanderer Plus - Size 9
403 27035	Wanderer Plus - Size 10
403 27036	Wanderer Plus - Size 10 1/2
403 27037	Wanderer Plus - Size 11

Stormbreak Waterproofs



CODE	DESCRIPTION
407 18300	Waterproof Overtrousers - S (Green)
407 18310	Waterproof Overtrousers - M (Green)
407 18320	Waterproof Overtrousers - L (Green)
407 18330	Waterproof Overtrousers - XL (Green)
407 18340	Waterproof Overtrousers - XXL (Green)
407 18350	Waterproof Overtrousers - XXXL (Green)
407 18460	Waterproof Jacket - S
407 18470	Waterproof Jacket - M
407 18480	Waterproof Jacket - L
407 18490	Waterproof Jacket - XL
407 18500	Waterproof Jacket - XXL
407 18510	Waterproof Jacket - XXXL

Two-tone Softshell Jacket



CODE	DESCRIPTION
407 21172	Premier - S (Green/Black)
407 21173	Premier - M (Green/Black)
407 21174	Premier - L (Green/Black)
407 21175	Premier - XL (Green/Black)
407 21176	Premier - XXL (Green/Black)
407 21177	Premier - XXXL (Green/Black)

Tempest Breathable Jacket



CODE	DESCRIPTION
406 21130	Breathable Waterproof Jacket - S (Green)
406 21140	Breathable Waterproof Jacket - M (Green)
406 21150	Breathable Waterproof Jacket - L (Green)
406 21160	Breathable Waterproof Jacket - XL (Green)
406 21170	Breathable Waterproof Jacket - XXL (Green)

Tempest Breathable Trousers



CODE	DESCRIPTION
407 18150	Breathable Waterproof Overtrousers - S (Green)
407 18160	Breathable Waterproof Overtrousers - M (Green)
407 18170	Breathable Waterproof Overtrousers - L (Green)
407 18180	Breathable Waterproof Overtrousers - XL (Green)
407 18190	Breathable Waterproof Overtrousers - XXL (Green)

Hi-Vis Waistcoats



CODE	DESCRIPTION
407 22600	Hi-Vis Waistcoat - M
407 22601	Hi-Vis Waistcoat - L
407 22602	Hi-Vis Waistcoat - XL
407 22603	Hi-Vis Waistcoat - XXL

Hi-Vis Motorway Jackets



CODE	DESCRIPTION
407 22610	Hi Vis Jacket - S
407 22620	Hi Vis Jacket - M
407 22630	Hi Vis Jacket - L
407 22640	Hi Vis Jacket - XL
407 22650	Hi Vis Jacket - XXL
407 22660	Hi Vis Jacket - XXXL

Hi-Vis Bomber Jackets



CODE	DESCRIPTION
408 22611	Hi Vis Bomber Jacket S
408 22612	Hi Vis Bomber Jacket - M
408 22613	Hi Vis Bomber Jacket - L
408 22614	Hi Vis Bomber Jacket - XL
408 22615	Hi Vis Bomber Jacket - XXL
408 22616	Hi Vis Bomber Jacket - XXXL

Short Life Overalls



CODE	DESCRIPTION
410 22670	Overalls - M (Hooded)
410 22680	Overalls - L (Hooded)
410 22690	Overalls - XL (Hooded)

Safety Goggles



CODE	DESCRIPTION
411 62010	Betafit Eiger 2802 Goggles Anti-Mist - Scratch Resistant

Safety Glasses



CODE	DESCRIPTION
411 62020	Betafit Geneva 2101 Safety Glasses

Safety Sun Glasses



CODE	DESCRIPTION
411 62021	Rush Lightweight Safety Sun Glasses

Browguard & Visor



CODE	DESCRIPTION
411 62000	Browguard & Visor

White Safety Helmet



CODE	DESCRIPTION
411 22300	Safety Helmet White

Standard Ear Muffs



CODE	DESCRIPTION
411 62050	Noisebeta 6100 Ear Muffs

Premium Ear Muffs



CODE	DESCRIPTION
411 62051	Noisebeta 6200 Ear Muffs

Respirators



CODE	DESCRIPTION
412 34250	Betafit Mask 3010 - 20/box
412 34260	Betafit Mask 3010v - 10/box
412 34270	Betafit Mask 3020 - 20/box
412 34280	Betafit Mask 3020v - 10/box
412 34290	Betafit Mask 3030v - 5/box

First Aid Kits



CODE	DESCRIPTION
413 62071	First Aid Kit Small (1-25)
413 62070	First Aid Kit Large (1-100)

Hand Wipes



CODE	DESCRIPTION
413 00208	Big Wipes Heavy Duty - 80
413 62060	The Cage (Big Wipe Holder)

A	Angle Iron Posts	67	Edging Knife	96	Linseed Oil	14
	Arris Rail Brackets	71	Electric Fencing - Accessories	44	Litter Picker	105
	Axes	100	Electric Fencing - Fieldguard	47	Loop Adapter	70
B	Ball floats	29	Electric Netting	47	Loppers	98
	Ball Valves	29	Electrified Polyrope / Wire	38	M	
	Balustrades	16	Electrified Polytape	39	Mattocks	104
	Barbed Tape	66	Energisers	38	Mauls	101
	Barbed Wire	35	Eyebolts	70	Measuring Jugs	107
	Barbed Wire Extenders	74	Ezecrimp Sleeves	28	Measuring Wheel	103
	Barrel Strainers	71	Ezecrimp Tool	28	Mulch Matting	92
	Barrier Fencing	68	F		Mulches	92
	Barrier Tape	68	Feather Edge Board	10	N	
	Batten - Panel Batten	10	Fertiliser	90	Nails - Galv	81
	Batten - Roofing Batten	19	Fieldguard Electric Fencing	47	Nails - Nail Fire	81
	Birds Mouth Straps	72	First Aid Kits	116	Nails - Spring Head Roofing Nails	81
	Blades	99	Forks	94	Net Guard	85
	Bollards	21	Frame Fixings	80	Netting Fastener Tool	28
	Bolts & Nuts - Cup Square Hex	79	Fuel Cans	106	Netting Fasteners	28
	Bolts & Nuts - Roofing Bolts	80	Funnels	106	Newel Posts	16
	Boots & Accessories	113	G		Nuts - Steel Hex	80
	Brackets	18	Galvanised Wire Netting	35	O	
	Broom Clamp	106	Gate Break Handles	43	Overalls	116
	Brushes	100	Gate Furniture	53-62	P	
	Brushing Hook	99	Gates - Electrified	42	Padbolts	60
	Buckets	104	Gates - Metal Gates	52	Padlocks	74
	Buckle Tree Ties	85	Gates - Posts	53	Paint Brushes	101
	Builders Line	105	Gates - Timber Gates	50	Pales - Timber Palisade Pales	13
C			Gloves	112	Paling - Chestnut Paling	27
	Cabin Hooks	60	Goggles	116	Panel Clips	13
	Cable Ties	86	Grass Seed	90	Panels - Closeboard Panels	11
	Canes	84	Gravel Board - Concrete	7	Panels - Lap Panels	10
	Capping - Closeboard Capping	9	Gravel Board - Timber	7	Panels - Timber Palisade Panels	13
	Capping - Panel Capping	10	Gravel Board Brackets	72	Pegs/Centre Stumps	9
	Chain - Fittings	22	Gripple Tensioning Tool	27	Pen Knives	106
	Chain - High Security	75	Gripples	27	Pick Heads	104
	Chain - Mending Links	22	Guying Systems	88	Pliers	102
	Chain - Spiked Chain	22	H		Plywood (Pine)	68
	Chain - Welded	76	Hairpin Staples	70	Poles - Machined Round Poles	20
	Chain Repair Link	76	Hammers	103	Porous Pipe & Fittings	110
	Chainlink	66	Hand Wipes	116	Post Caps	6
	Chainlink Accessories	70	Handles	105	Post Driver	102
	Chainlink Posts	67	Handrail	16	Post Hole Diggers	101
	Chestnut Fencing	27	Hasp & Staple	60	Post Supports	15
	Cleats - Angle	70	Helmet	116	Postfix	14
	Cleats - Twin Pin	72	Hinges	53-57	Posts - Concrete	7
	Compost	90	Hi-Vis Clothing	115	Posts - Electric Fencing Posts	43
	Contact Breaker - Electric Fencing	45	Hoe	96	Posts - Gate Posts	53
	Creosote	14	Hose Pipe	108	Posts - HC4 Square Sawn Pointed	26
	Crimp Sleeve Tool	28	Hose Pipe Fittings	108	Posts - Timber	6
	Crimp Sleeves	28	Hose Reel Stands	111	Posts - Timber Birds Mouth Posts	21
	Crowbars	105	Hurdles - Wattle Hurdles	13	Preservers - Wood Preservers	14
D			I		Pruners	99
	Decking - Timber Boards/Accessories	16	Insulators - Electric Fencing	40	PTFE Tape	29
	Dee Shackle	76	Ironmongery	18	R	
	Dragons Teeth	21	Irrigation Systems	87	Rabbit Netting	35
	Drill Bits	104	J		Rails - Arris Rails	9
	Driver Bits	18	Joists	19	Rails - Cant Rail	9
	Drop Bolt	61	Jubilee Clips	111	Rails - Capping Rail	9
E			K		Rails - Cleft Chestnut Rails	27
	Ear Muffs	116	Knee Rail - Timber	21	Rails - Counter Rail	9
	Earth Rammer	101	L		Rails - Cundy Peeled Half Round Rails	24
			Levels	103	Rails - Machined Half Round Rails	20
			Line Hooks	82	Rails - Square Sawn Rails	19

Rakes	96	Spiral Guards	85	Tree Pads	86
Ratchet Straps	105	Spirit Level	103	Tree Stakes	84
Razor Wire	66	Splitting Mauls	100	Tree Strapping	86
Repair Spurs - Concrete	9	Splitting Wedges	100	Tree Ties	85
Respirators	116	Spray Lances & Nozzles	107	Trellis - Crescent Trellis	11
Ring - Manger Ring	26	Sprayers	108	Trellis - Dome Trellis	11
Ring Clip Pliers	28	Sprayers - Service Kits	108	Trellis - Fan Trellis	11
Ring Clips	28	Spreaders	104	Trellis - Premier English Trellis	12
Ring On Plate	26	Sprinklers	110	Trellis - Privacy Diamond Trellis	12
Root Directors	87	Stakes - HC4 Cundy Peeled Round	24	Trellis - Square Trellis	11
Root Securing Systems	88	Stakes - HC4 Machine Round Pointed	25	Trowel & Weed fork	96
Root Watering Systems	87	Stakes - Machined Half Round Pointed	20	Tubex Tree Shelters	84
Rope - Blue Poly Rope	105	Stakes - Machined Round Pointed	20	V	
Rope - Wire	75	Stakes - Pointed/Peeled Half Round	24	Vine Eyes	82
S		Stakes - Pointed/Peeled Round	24	Visor	116
Sack Ties	105	Staple Gun & Staples	104	W	
Sacks	105	Staple on Plate	26	Wall Plugs - Nylon	80
Safety Glasses	116	Staples	82	Wall Plugs - Plastic	81
Safety Helmet	116	Stock Fence	34	Washers	80
Salt	14	Strainers	71	Water Pipe	29
Saws	97	Strainers - Pointed/Peeled Round	24	Water Pipe Fittings	30
Screen Panel - Premier Salisbury	13	Strainers - HC4 Cundy Peeled Pointed	24	Water Trough Service Box	29
Screws - Hex Head (Carpenters Mate)	18	Strainers - Machine Round Pointed	25	Water Troughs	29
Screws - Hex Head Coachscrews	78	Straps - Birds Mouth Straps	21	Waterproof Clothing	115
Screws - Woodscrews	78	Stretcher Bar	70	Weed Mat Pegs	92
Scythe Stones	99	Struts - Round Timber Struts	24	Weed Matting	92
Seat Covers	106	Surveyors Tape Measure	103	Welded Mesh	66
Secateurs & Accessories	99	T		Wheelbarrows	104
Shears	98	Tape - Duct Tape	111	Windbreak	92
Shelter Stakes	84	Tape - PTFE Tape	29	Wire	34
Shield Anchor Bolts	80	Tape Measure	103	Wire Connectors - Gripples	27
Shovels	95	Taps - Brass	29	Wire Connectors - Twistlink	27
Sleepers - Garden Sleepers	20	Tarpaulins	105	Wire Cutters	102
Sleepers - Oak	20	Thunder Bolt Fixings	81	Wire Dispensers	102
Slip Rail Bracket	26	Tie Wire	34	Wire Rope	75
Spades	94	Torches	111	Wire Rope Fittings	75
Spindles - Turned Spindles	16	Tree Guards	85	Wire Strainers	102

1 Interpretation

1.1 In these Terms: 'Buyer' means the person who accepts the Seller's written quotation for the sale of the Goods or whose written order for the Goods is accepted by the Seller; 'Goods' means the goods (including any instalment of the goods or any parts of them) which the Seller is to supply in accordance with these Terms; 'Seller' means ATF Supplies Nationwide Ltd or its branch office, Unit 36A Walworth Business Park, Andover, Hampshire, SP10 5LH; 'Contract' means the contract for the sale and purchase of the Goods; 'Terms' means the standard terms of sale set out in this document and (unless the context otherwise requires) includes any special terms agreed in writing between the Buyer and the Seller; 'writing' and any similar expression, includes facsimile transmission but not electronic mail or other forms of electronic communication; 1.2 A reference in these Terms to a provision of a statute shall be construed as a reference to that provision as amended, re-enacted or extended at the relevant time; 1.3 The headings in these Terms are for convenience only and shall not affect their interpretation; 2 **Basic of sale** 2.1 The Seller shall sell and the Buyer shall purchase the Goods in accordance with the Seller's written quotation (if accepted by the Buyer), or the Buyer's written order (if accepted by the Seller), subject in either case to these Terms, which shall govern the Contract to the exclusion of any other terms subject to which any such quotation is accepted or purported to be accepted, or any such order is made or purported to be made, by the Buyer; 2.2 No variation to these Terms shall be binding unless agreed in writing between the authorised representatives of the Buyer and the Seller. The authorised representatives of the Seller are: Mr. Tim Diplock and Mr. Simon Diplock and Mr Sheldon Diplock and Mr Braden Diplock and Mr Rol Diplock; 2.3 The Seller's employees or agents are not authorised to make any representations concerning the Goods unless confirmed by the Seller in writing, in entering into the Contract the Buyer acknowledges that it does not rely on any such representations which are not so confirmed, but nothing in these Terms affects the liability of either party for fraudulent misrepresentation; 2.4 Any advice or recommendation given by the Seller or its employees or agents to the Buyer or its employees or agents as to the storage, application or use of the Goods which is not confirmed in writing by the Seller is followed or acted on entirely at the Buyer's own risk, and accordingly the Seller shall not be liable for any such advice or recommendation which is not so confirmed; 2.5 Any typographical, clerical or other error or omission in any sales literature, quotation, price list, agreement of offer, invoice or other document or information

issued by the Seller shall be subject to correction without any liability on the part of the Seller; 3 **Orders and specifications** 3.1 No order submitted by the Buyer shall be deemed to be accepted by the Seller unless and until confirmed in writing by the Seller's authorised representative; 3.2 The Buyer shall be responsible to the Seller for ensuring the accuracy of the terms of any order (including any applicable specification) submitted by the Buyer, and for giving the Seller any necessary information relating to the Goods within a sufficient time to enable the Seller to perform the Contract in accordance with its terms; 3.3 The quantity, quality and description of the Goods and any specification for them shall be as set out in the Seller's quotation (if accepted by the Buyer) or the Buyer's order (if accepted by the Seller); 3.4 If the Goods are to be manufactured or any process is to be applied to the Goods by the Seller in accordance with a specification submitted by the Buyer, the Buyer shall indemnify the Seller against all loss, damages, costs and expenses awarded against or incurred by the Seller in connection with, or paid or agreed to be paid by the Seller in settlement of, any claim for infringement of any patent, copyright, design, trade mark or other industrial or intellectual property rights of any other person which results from the Seller's use of the Buyer's specification; 3.5 The Seller reserves the right to make any changes in the specification of the Goods which: (a) are required to conform with any applicable statutory or E.U. requirements; or (b) (where the Goods are to be supplied to the Seller's specification) which do not materially affect their quality or performance; 3.6 Subject to clause 3.7 below, no order which has been accepted by the Seller may be cancelled by the Buyer except with the agreement in writing of the Seller and on terms that the Buyer shall indemnify the Seller in full against all loss (including loss of profit), costs (including the cost of all labour and materials used), damages, charges and expenses incurred by the Seller as a result of cancellation; 3.7 Where the Goods are sold under a consumer transaction and the Consumer Protection (Distance Selling) Regulations 2000 apply, you may cancel the Contract at any time up to the end of seven working days after you receive the Goods by giving written notice to the Seller specifying details of the Goods ordered and (where appropriate) their delivery. A working day is any day other than weekends and bank or other public holidays. If you exercise your right of cancellation after the goods have been delivered to you, you must (at your own cost) return the Goods to the Seller at the Seller's address shown opposite. You must ensure the goods are not damaged prior to their return. Once you have notified the Supplier that you are cancelling the Contract, the Supplier will refund or re-credit you within 30 days for any sum that has been paid by you or debited from your credit card for the Goods. If you do not



return the Goods as required, the Seller may charge you a sum not exceeding the direct costs of recovering the Goods; 4 **Price of the goods** 4.1 The price of the Goods shall be the Seller's quoted price or, where no price has been quoted (or a quoted price is no longer valid), the price listed in the Seller's published price list current at the date of acceptance of the order. All prices quoted are valid for 30 days only or until earlier acceptance by the Buyer, after which time they may be altered by the Seller without giving notice to the Buyer; 4.2 The Seller reserves the right, by giving written notice to the Buyer at any time before delivery, to increase the price of the Goods to reflect any increase in the cost to the Seller which will factor beyond the control of the Seller (such as, without limitation, any foreign exchange fluctuation, currency regulation, alteration of duties, significant increase in the costs of labour, materials or other costs of manufacture), any change in delivery dates, quantities or specifications for the Goods which is requested by the Buyer, or any delay caused by any instructions of the Buyer or failure of the Buyer to give the Seller adequate information or instructions; 4.3 Except as otherwise stated in the Seller's written quotation or in any price list of the Seller, and unless otherwise agreed in writing between the Buyer and the Seller, all prices are given by the Seller on an ex-works basis, and where the Seller agrees to deliver the Goods otherwise than at the Seller's premises, the Buyer shall be liable to pay the Seller's charges for transport, packaging and insurance; 4.4 The price is exclusive of any applicable value added tax, which the Buyer shall be additionally liable to pay to the Seller; 4.5 The cost of pallets and returnable containers will be charged to the Buyer in addition to the price of the Goods, but full credit will be given to the Buyer provided they are returned undamaged to the Seller before the due payment date; 5 **Terms of payment** 5.1 Subject to any special terms agreed in Writing between the Buyer and the Seller, the Seller may invoice the Buyer for the price of the Goods on or at any time after delivery of the Goods, unless the Goods are to be collected by the Buyer or the Buyer wrongfully fails to take delivery of the Goods, in which event the Seller shall be entitled to invoice the Buyer for the price at any time after the Seller has notified the Buyer that the Goods are ready for collection or (as the case may be) the Seller has tendered delivery of the Goods; 5.2 The Buyer shall pay the price of the Goods (less any discount to which the Buyer is entitled, but without any other deduction): (a) if the Buyer is not an account customer, at the time of order; or (b) if the Buyer is an account customer, within 28 days of the date of the Seller's invoice, and the Seller shall be entitled to recover the price, notwithstanding that delivery may not have taken place and the property in the Goods has not passed to the Buyer. The time of payment of the price shall be of the essence of the Contract. Receipts for payment will be issued only on request; 5.3 If the Buyer fails to make any payment on the due date then, without limiting any other right or remedy available to the Seller, the Seller may: (a) cancel the contract or suspend any further deliveries to the Buyer; (b) appropriate any payment made by the Buyer to such of the Goods (or the goods supplied under any other contract between the Buyer and the Seller) as the Seller may think fit (notwithstanding any purported appropriation by the Buyer); and (c) charge the Buyer interest (both before and after any judgment) on the amount unpaid, at the rate of 3½% per annum above the base lending rate of Lloyds TSB Bank Plc from time to time, until payment in full is made (a part of a month being treated as a full month for the purpose of calculating interest); 6 **Delivery** 6.1 Delivery of the Goods shall be made by the Buyer collecting the Goods at the Seller's premises at any time after the Seller has notified the Buyer that the Goods are ready for collection or, if some other place for delivery is agreed by the Seller, by the Seller delivering the Goods to that place; 6.2 Any dates quoted for delivery of the Goods are approximate only and the Seller shall not be liable for any delay in delivery of the Goods however caused. Time for delivery shall not be of the essence of the Contract unless previously agreed by the Seller in Writing. The Goods may be delivered by the Seller in advance of the quoted delivery date on giving reasonable notice to the Buyer; 6.3 Where delivery of the Goods is to be made by the Seller in bulk, the Seller reserves the right to deliver up to 5% per cent more or less than the quantity ordered without any adjustment in the price, and the quantity so delivered shall be deemed to be the quantity ordered; 6.4 Where the Goods are to be delivered in instalments, each delivery shall constitute a separate contract and failure by the Seller to deliver any one or more of the instalments in accordance with these Terms or any claim by the Buyer in respect of any one or more instalments shall not entitle the Buyer to treat the Contract as a whole as repudiated; 6.5 If the Seller fails to deliver the Goods (or any instalment) for any reason other than any cause beyond the Seller's reasonable control or the Buyer's fault, and the Seller is accordingly liable to the Buyer, the Seller's liability shall be limited to the excess (if any) of the cost to the Buyer (in the cheapest available market) of similar goods to replace those not delivered over the price of the Goods; 6.6 If the Buyer fails to take delivery of the Goods or fails to give the Seller adequate delivery instructions at the time stated for delivery (otherwise than by reason of any cause beyond the Buyer's reasonable control or by reason of the Seller's fault) then, without limiting any other right or remedy available to the Seller, the Seller may: (a) store the Goods until actual delivery and charge the Buyer for the reasonable costs (including insurance) of storage; or (b) sell the Goods at the best price readily obtainable and (after deducting all reasonable storage and selling expenses) account to the Buyer for the excess over the price under the Contract or charge the Buyer for any shortfall below the price under the Contract; 7 **Risk and property** 7.1 Risk of damage to or loss of the Goods shall pass to the Buyer: (a) in the case of Goods to be delivered at the Seller's premises, at the time when the Seller notifies the Buyer that the Goods are available for collection; or (b) in the case of Goods to be delivered otherwise than at the Seller's premises, at the time of delivery or, if the Buyer wrongfully fails to take delivery of the Goods, the time when the Seller has tendered delivery of the Goods; 7.2 Notwithstanding delivery and the passing of risk in the Goods, or any other provision of these Terms, the property in the Goods shall not pass to the Buyer until the Seller has received in cash or cleared funds payment in full of the price of the Goods and all other goods agreed to be sold by the Seller to the Buyer for which payment has then been made; 7.3 Until such time as the property in the Goods passes to the Buyer, the Buyer shall hold the Goods as the Seller's fiduciary agent and bailee, and shall keep the Goods separate from those of the Buyer and third parties and properly stored, protected

and insured and identified as the Seller's property, but the Buyer may resell or use the Goods in the ordinary course of its business; 7.4 Until such time as the property in the Goods passes to the Buyer (and provided the Goods are still in existence and have not been resold), the Seller may at any time require the Buyer to deliver to the Seller and, if the Buyer fails to do so forthwith, enter on any premises of the Buyer or any third party where the Goods are stored and repossess the Goods; 7.5 The Buyer shall not be entitled to pledge, create a lien over or in any way charge by way of security for any indebtedness any of the Goods which remain the property of the Seller, but if the Buyer does so all monies owing by the Buyer to the Seller shall (without limiting any other right or remedy of the Seller) forthwith become due and payable; 8 **Warranties and liability** 8.1 Subject to clauses 8.2 and 8.3 below, except where the Goods are sold to a person dealing as a consumer (within the meaning of the Unfair Contract Terms Act 1977), all warranties, conditions or other terms implied by statute or common law are excluded to the fullest extent permitted by law. Without limitation to the foregoing, the Seller shall be under no liability (if the total price for the Goods has not been paid by the due date for payment or in respect of any defect in the Goods arising from: (a) any drawing, design or specification supplied by the Buyer; or (b) fair wear and tear, willful damage, negligence, abnormal working conditions, failure to follow the Seller's or manufacturer's instructions (whether oral or in writing), misuse or alteration or repair of the Goods without the Seller's approval; 8.2 In respect of all parts or materials or equipment of the Seller, the Seller, the Buyer shall only be entitled to the benefit of such warranty or guarantee (if any) as is given by the manufacturer to the Seller; 8.3 Where the Goods are sold under a consumer transaction (as defined by the Consumer Transactions (Restrictions on Statements) Order 1976) the statutory rights of the Buyer are not affected by these Terms; 8.4 A claim by the Buyer which is based on any defect in the quality or condition of the Goods or their failure to correspond with specification shall (whether or not delivery is refused by the Buyer) be notified to the Seller within seven days from the date of delivery or (where the defect or failure was not apparent on reasonable inspection) within a reasonable time after discovery of the defect or failure. If delivery is not refused, and the Buyer does not notify the Seller accordingly, the Buyer shall not be entitled to reject the Goods and the Seller shall have no liability for such defect or failure, and the Buyer shall be bound to pay the price as if the Goods had been delivered in accordance with the Contract. In no event shall the Buyer be entitled to reject the Goods on the basis of any defect or failure which is so slight that it would be unreasonable for him to reject them; 8.5 Where a valid claim in respect of any of the Goods which is based on a defect in the quality or condition of the Goods or their failure to meet specification is notified to the Seller in accordance with these Terms, the Seller may replace the Goods (or the part in question) free of charge or, at the Seller's sole discretion, refund to the Buyer the price of the Goods (or a proportionate part of the price), in which case the Seller shall have no further liability to the Buyer; 8.6 Except in respect of death or personal injury caused by the Seller's negligence, or liability for defective products under the Consumer Protection Act 1987, the Seller shall not be liable to the Buyer by reason of any representation (unless fraudulent), or any implied warranty, condition or other term, or any duty at common law, or under the express terms of the Contract, for loss of profit or for any indirect, special or consequential loss or damage, costs, expenses or other claims for compensation whatsoever (whether caused by the negligence of the Seller, its employees or agents or otherwise) which arise out of or in connection with the supply of the Goods (including any delay in supplying or any failure to supply the Goods in accordance with the Contract or at all or their use or resale by the Buyer, and the entire liability of the Seller under or in connection with the Contract shall not exceed the price of the Goods, except as expressly provided in these Terms; 8.7 The Seller shall not be liable to the Buyer or be deemed to be in breach of the Contract by reason of any delay in performing, or any failure to perform, any of the Seller's obligations in relation to the Goods, if the delay or failure was due to any cause beyond the Seller's reasonable control; Without limiting the foregoing, the following shall be regarded as causes beyond the Seller's reasonable control: (a) Act of God, explosion, flood, tempest, fire or accident; (b) war or threat of war, sabotage, insurrection, civil disturbance or requisition; (c) acts, restrictions, regulations, bye-laws, prohibitions or measures of any kind on the part of any governmental, parliamentary or local authority; (d) import or export regulations or embargoes; (e) strikes, lock-outs or other industrial actions or trade disputes (whether involving employees of the Seller or of a third party); (f) difficulties in obtaining raw materials, labour, fuel, parts or machinery; (g) power failure or breakdown in machinery; 9 **Insolvency of Buyer** 9.1 This clause 9 applies if: (a) the Buyer makes a composition or voluntary arrangement with its creditors or (being an individual or firm) becomes bankrupt or (being a company) enters administration or goes into liquidation (otherwise than for the purposes of amalgamation or reconstruction), or a moratorium comes into force in respect of the Buyer (within the meaning of the Insolvency Act 1986); or (b) an encumbrancer takes possession, or a receiver is appointed, of any of the property or assets of the Buyer; 9.2 If the Buyer ceases, or threatens to cease, to carry on business; or (c) the Seller reasonably apprehends that any of the events mentioned above is about to occur in relation to the Buyer and notifies the Buyer accordingly; 9.2 If this clause applies then, without limiting any other right or remedy available to the Seller, the Seller may cancel the Contract or suspend any further deliveries under the Contract without any liability to the Buyer, and if the Goods have been delivered but not paid for the price shall become immediately due and payable notwithstanding any previous agreement or arrangement to the contrary; 10 **General** 10.1 A notice required or permitted to be given by either party to the other under these Terms shall be in writing addressed to that other party at its registered office or principal place of business (or such other address as may at the relevant time have been notified pursuant to this provision to the party giving the notice); 10.2 No waiver by the Seller of any breach of the Contract by the Buyer shall be considered as a waiver of any subsequent breach of the same or any other provision; 10.3 If any provision of the Contract is held by a court or other competent authority to be invalid or unenforceable in whole or in part the validity of the other provisions of the Contract and any remainder in force and effect shall not be affected; 10.4 The Contract shall be governed by the law of England, and the Buyer agrees to submit to the non-exclusive jurisdiction of the English courts.

Garden Fencing



Planting Sundries



Tools & Workwear



Decking & Accessories



Gates & Gate Furniture



Agricultural Fencing



Electric Fencing



Security Fencing & Products



01264 366 211

sales@atfsuppliesuk.com
www.atfsuppliesuk.com

Trade Store Hours:
07:00 – 5:00 Monday to Friday

ATF Supplies, Boundary House, 36a Walworth
Business Park, Andover, Hampshire. SP10 5LH